

Leviat[®]
A CRH COMPANY

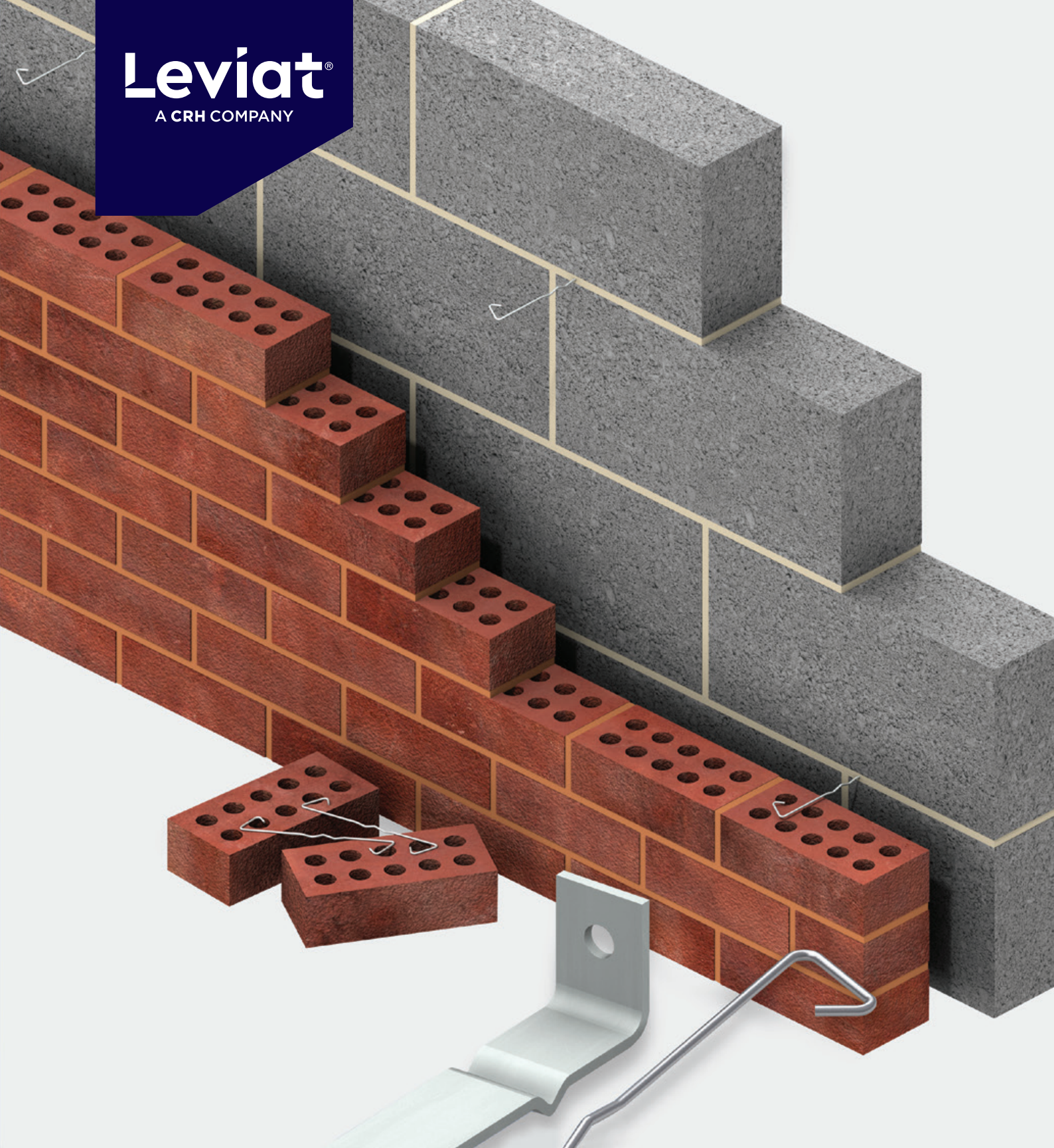

Ancon[®]

Wall Ties and Restraint Fixings

for the Construction Industry



We are one team. **We are Leviat.**

Leviat is the new name of CRH's construction accessories companies worldwide.

Under the Leviat brand, we are uniting the expertise, skills and resources of Ancon and its sister companies to create a world leader in fixing, connecting and anchoring technology.

The products you know and trust will remain an integral part of Leviat's comprehensive brand and product portfolio. As Leviat, we can offer you an extended range of specialist products and services, greater technical expertise, a larger and more agile supply chain and better, faster innovation.

By bringing together CRH's construction accessories family as one global organisation, we are better equipped to meet the needs of our customers, and the demands of construction projects, of any scale, anywhere in the world.

This is an exciting change. Join us on our journey.

Read more about Leviat at [Leviat.com](https://www.leviat.com)



Our product brands include:

Ancon[®]

Connolly

H
HALFEN

HELIFIX

ISEDIO

PLAKA



60

locations

sales in
30+
countries

3000

people worldwide

Imagine. Model. Make.

Leviat.com

Wall Ties and Restraint Fixings

For building with brick, block and stone

Wall ties and restraint fixings are an essential element in the stability of masonry panels.

Leviat manufactures fixings in a variety of lengths and types for restraining brickwork, blockwork and stonework. Restraints can be fixed to concrete and structural steelwork as well as any type of masonry. Products are manufactured from stainless steel unless stated otherwise.

The range of standard ties provides a solution for all types of wall construction.



Contents

Cavity Wall Tie Selection	6-7	Cast-in Slots, Channels & Fastrack	14
Standard Wall Ties	8	Two-Part Ties & Wall Starter	15
Bespoke Wall Tie References	9	Restraints for Stone Cladding	16-19
Installation Guidance	10	Head Restraints	20-21
Veneer Ties	11	Remedial Wall Ties	22-23
Ties for Thin-Joint Blockwork	11	Masonry Reinforcement	24
Vertical Movement Joints	12	Other Ancon Products	24
Frame Cramps	13		





Wall Ties and Restraint Fixings

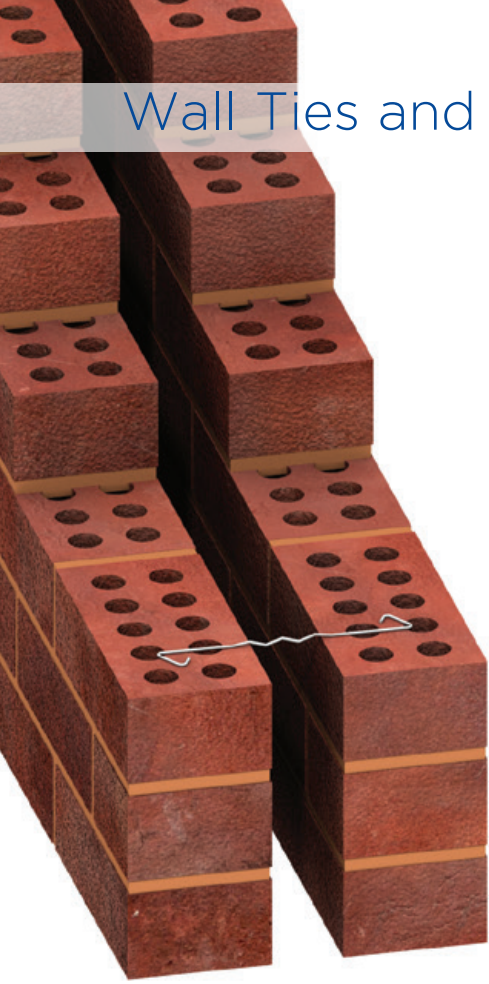

Cavity Wall Tie Selection

Wall ties should be selected in accordance with the Australian Standards on Masonry Structures and Masonry Ties (AS3700 and AS2699). Selection is based on the distance of the structure from the coast and whether that coast opens to a sheltered bay or clear ocean. Grade 316 stainless steel ties cover durability exposure classification R2, R3 and R4. Grade 304 ties cover R2 and R3. Please consult the information on this page or contact us for advice on the best selection of wall ties for your application.

Durability Exposure Map

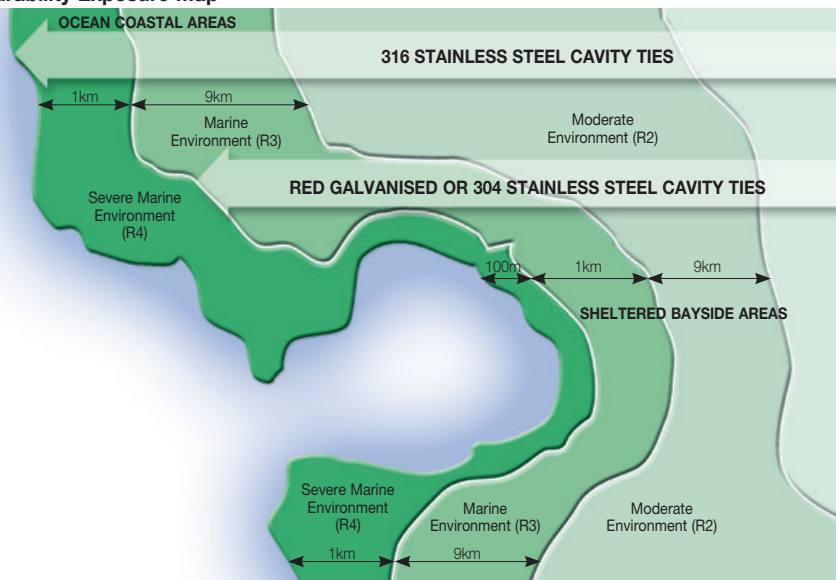

Ocean Coastal Areas

	0-1km severe marine	1-9km marine	>10km mod - mild
Steel Sheet Ties	316 Stainless Steel (R4)	316 Stainless Steel (R4) 304 Stainless Steel (R3) Hot Dipped Galv, 470G/M ² (R3)	316 Stainless Steel (R4) 304 Stainless Steel (R3) Galvanised Z600 (R2)
Steel Wire Ties	316 Stainless Steel (R4)	316 Stainless Steel (R4) 304 Stainless Steel (R3) Hot Dipped Galv, 470G/M ² (R3)	316 Stainless Steel (R4) 304 Stainless Steel (R3) Hot Dipped Galv, 470G/M ² (R3)

Sheltered Bayside Areas

	0 - 100mtrs severe marine	100mtrs - 1 km marine	1 - 9 kms moderate >	10 kms mod - mild
Steel Sheet Ties	316 Stainless Steel (R4)	316 Stainless Steel (R4) 304 Stainless Steel (R3) Hot Dipped Galv, 470G/M ² (R3)	316 Stainless Steel (R4) 304 Stainless Steel (R3) Galvanised Z600 (R2)	316 Stainless Steel (R4) 304 Stainless Steel (R3) Galvanised Z600 (R2)
Steel Wire Ties	316 Stainless Steel (R4)	316 Stainless Steel (R4) 304 Stainless Steel (R3) Hot Dipped Galv, 470G/M ² (R3)	316 Stainless Steel (R4) 304 Stainless Steel (R3) Hot Dipped Galv, 470G/M ² (R3)	316 Stainless Steel (R4) 304 Stainless Steel (R3) Hot Dipped Galv, 470G/M ² (R3)

Strength Requirements for Type A Cavity Ties in Housing

Location	Classification	Horizontal Spacing (mm)		
		300	450	600
Sydney	N3	M	M	M
Melbourne	N3	M	M	M
Brisbane	N4	M	H	H
Adelaide	N3	M	M	M
Perth	N3	M	M	M
Hobart	N3	M	M	M
Darwin	C3	H	H	H
Townsville	C3	H	H	H
Cairns	C3	H	H	H

Any wall height, vertical tie spacing 600mm

Notes

- M = Medium duty, H = Heavy duty.
- The table is based on wind pressures calculated for ultimate-strength limit-state design based on the external pressure coefficients applicable to the worst case for general wall areas in AS 4055 Appendix B.
- AS 4055 classifications have been chosen as typical of developing areas in major cities. Terrain category of 2.5 is typical of developing outer urban areas and is conservative for more developed areas with a larger number of obstructions. Partial shielding is typical of intermediate situations such as acreage-type suburban development or wooded parkland and is conservative for more heavily developed or wooded areas. A topographic classification of T3 covers locations on hills up to 1:5 slope and escarpments.
- For houses in more severe exposure conditions, such as coastal sites and the tops of hills (1:5 slope or greater) the individual site should be classified in accordance with AS 4055 and tables based on wind classification should be used.
- Required tie ratings are based on the load capacities given in AS 3700-1998 (as amended 1999).
- Ratings are based on tie forces of 1.3 times the tributary area, as required in AS 3700 Clause 7.7.3 for veneer walls with a stiff structural backing. This situation applies to cavity walls in houses where only the inner leaf is supported (see AS 3700 Clause 7.8.4).
- At intersecting walls, AS 3700 Clause 7.7.2(a) requires double the number of ties.
- The first row of ties adjacent to all edges, lateral supports, control joints and opening is required by AS 3700 Clause 4.10 (d) to be within 300mm of the edge, line of support, joint or opening.

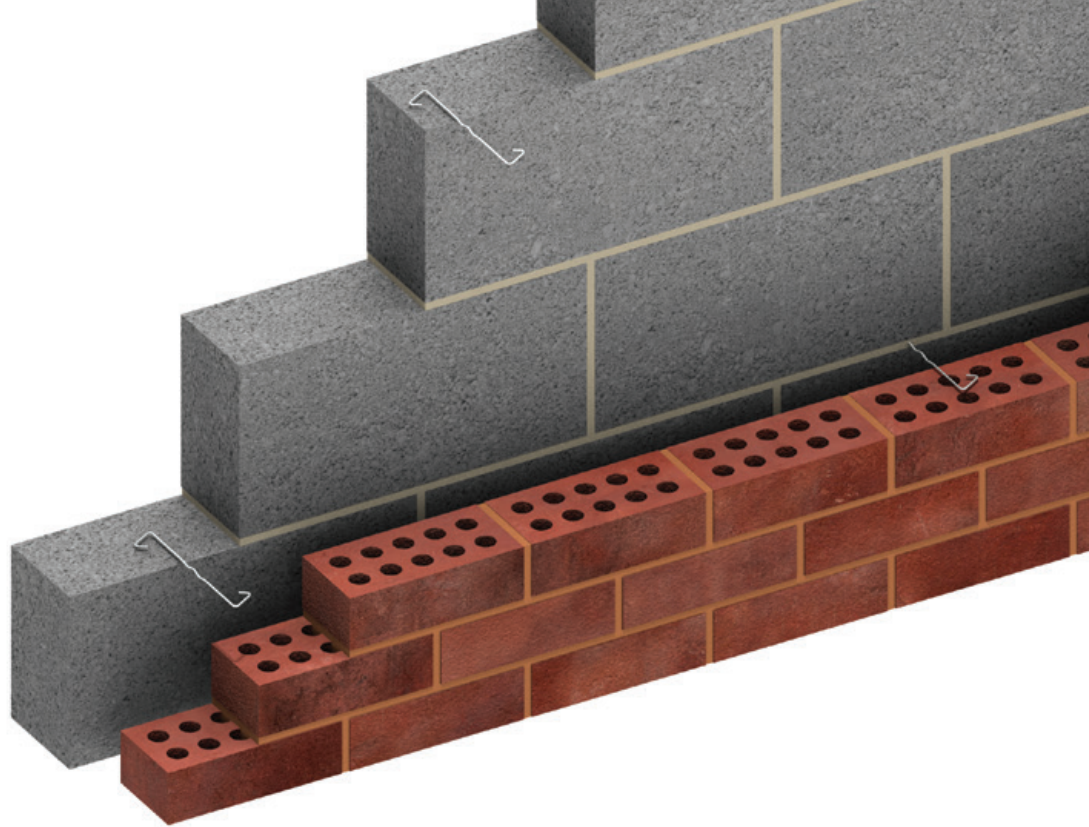

Spacing for medium duty wall ties - cavity and veneer construction

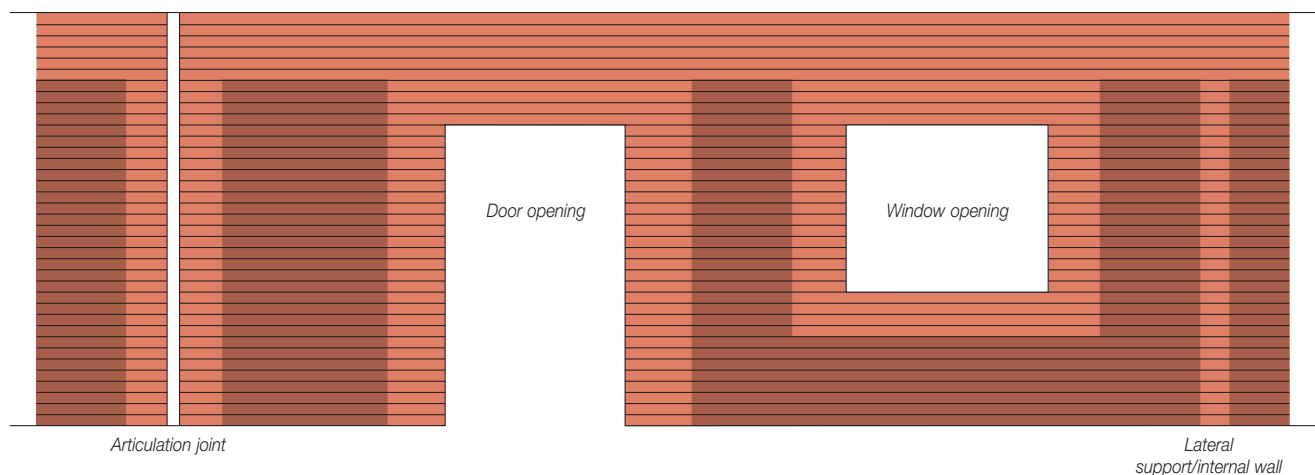

Table a. Spacing for medium duty wall ties - cavity and veneer construction

Design Wind Speed (non-cyclonic)	Cavity Masonry	Masonry Veneer Construction	
		450 Stud Walls	600 Stud Walls
W28-W41	600x600	600x450	600x600

Notes

1. Inner leaf masonry thickness 70 to 150mm for cavity walls.
2. Around openings and at control joints, the vertical tie spacings are halved (ie the number of ties must be doubled).
3. In veneer construction, masonry must be tied to stud wall framing at all regular stud positions, including gable ends.

Length of Tie & Embedment

Wall ties should be of the correct length to ensure they are properly embedded in the masonry. The tie should have a minimum embedment of 50mm in each leaf but also take site tolerances into account for both cavity width and centring of the tie. For this reason we suggest tie lengths which achieve an embedment of between 62.5mm and 75mm.

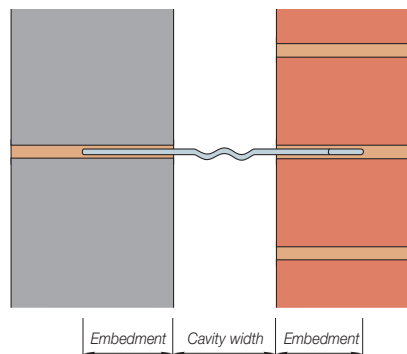

Embedment of Wall Ties

Recommended lengths to suit various cavity widths are shown on page 8 for masonry-to-masonry wall ties.

Wall Ties and Restraint Fixings

Standard Wall Ties

Our Technical Services Team will be pleased to advise on the correct selection and use of our wall ties.

Staifix AMD Cavity Tie (medium duty)

Lengths 200, 225mm
Available in 304 stainless steel (R3) and 316 stainless steel (R4).
Safety end provides excellent mortar key. Multiple drip formation allows it to be installed either way up

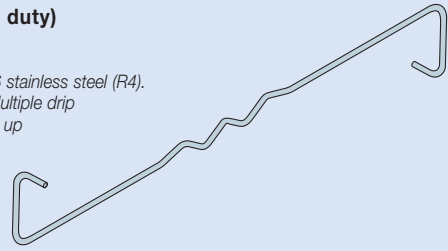

ST1

Lengths 200, 225, 250, 275, 300mm
Conforms to PD 6697 as a Type 1 tie
U.K. Patent Nos. 2 255 358, 2 260 348 & 2 260 349

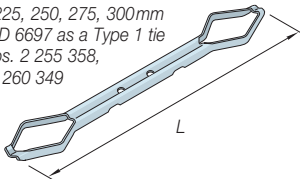

SD1

Lengths 200, 225, 250, 275, 300mm
Conforms to PD 6697 as a Type 1 tie.
Also available with a central drip.

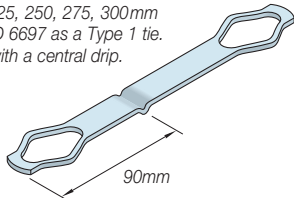

SPB

Lengths 75, 100, 125, 150, 175, 200mm

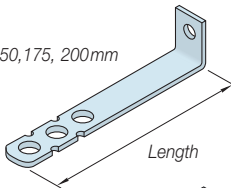

SDB

Lengths 125, 150, 175, 200, 225mm

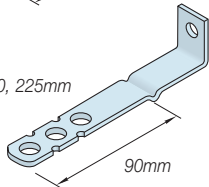

PPB

Lengths 125, 150, 175, 200, 225mm

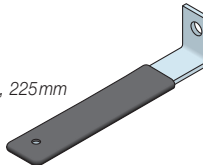

SPV

Lengths 75, 100, 125, 150, 175, 200mm.

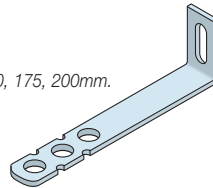

SDV

Lengths 125, 150, 175, 200, 225mm

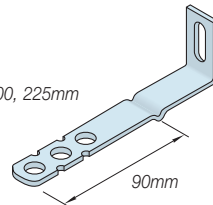

PPV

Lengths 125, 150, 175, 200, 225mm

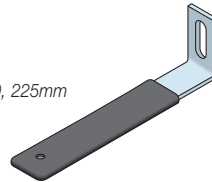

SP21

Lengths 75, 100, 125, 150, 175, 200mm
For use with 21/18
Omega Channel

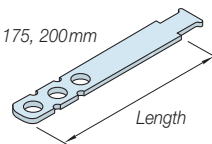

SD21

Lengths 125, 150, 175, 200, 225mm
For use with 21/18
Omega Channel

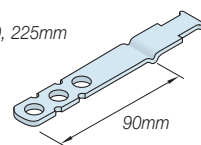

PP21

Lengths 125, 150, 175, 200, 225mm
For use with 21/18
Omega Channel

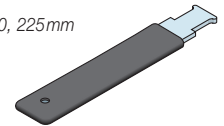

SPS

Lengths 150, 200, 225, 250, 275, 300mm
(Not suitable for collar-jointed construction. See below)

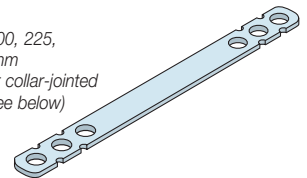

SPS CJ

Length 150mm
(3mm thickness for collar-jointed construction)

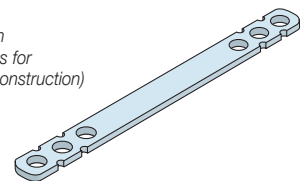

PPS

Lengths 225, 250mm

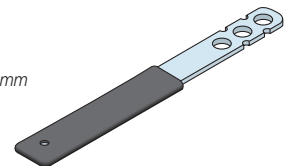

WHX

Lengths 150, 175, 200mm

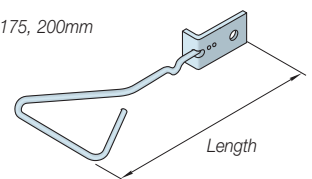

Recommended Lengths for Masonry/ Masonry Wall Ties

Cavity Width (mm)	Tie Length (mm)
50-75	200
76-100	225
101-125	250
126-150	275
151-175	300

Recommended Lengths for Frame Cramps and Cast-in Channel Ties*

Cavity Width (mm)	Tie Length (mm)
<20	75
20-44	100
45-69	125
70-94	150
95-119	175
120-144	200
145-169	225

*Excluding Fastrack

SRB

Lengths 125, 150, 175, 200mm

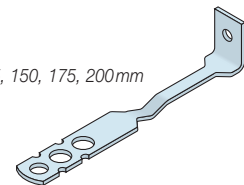

References for Wall Ties

Many variations are available in addition to the standard ties. Wall ties for special applications may be specified and ordered with ease by using a reference letter for the tail, shank and head of the tie.

Ancon ties are produced in lengths from 150mm for masonry-to-masonry ties, and 75mm for masonry-to-concrete ties, in increments of 25mm. Drips will usually be positioned 90mm from the outer end of the tie. Masonry-to-masonry ties can also be supplied with a central drip. Special wall ties with a section wider than 20mm referenced S__, will have an end with three holes without the side notches.

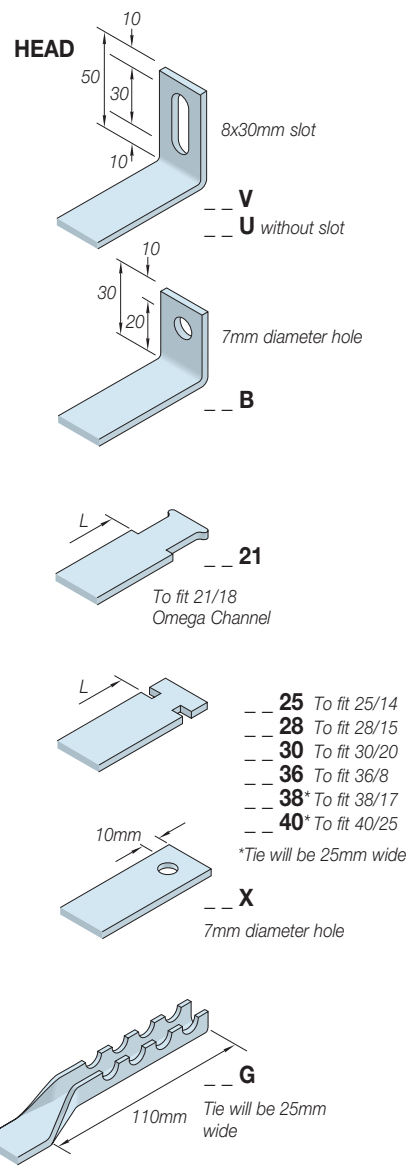
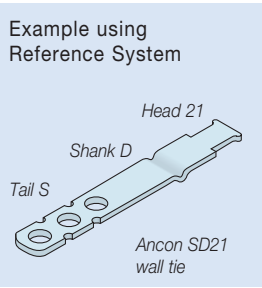

TAIL
Most can be used at either end of tie

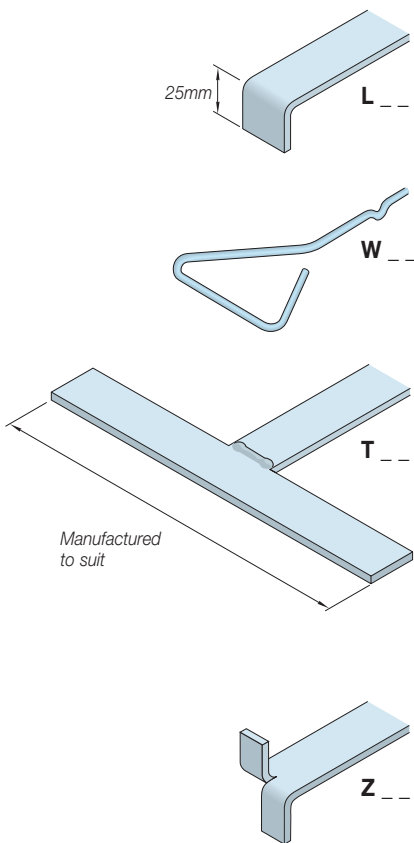
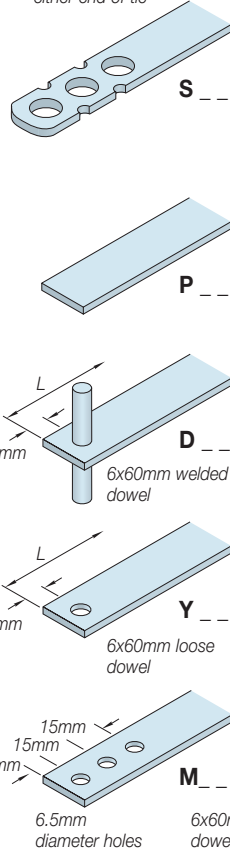

Insulation Retaining Clips

The red Staifix Insulation Retaining Clip will fit all the standard ties shown on page 8.

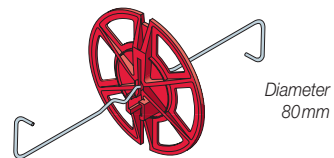

Insulation Retainer

The H75/2 Insulation Retainer is for securing material to concrete, blockwork and brickwork. The 90mm diameter head can hold back up to 75mm of insulation. A 10mm diameter hole is required in the base material. The projecting end of the retainer is pushed through the insulation material into the hole and tapped into position to secure the insulation.

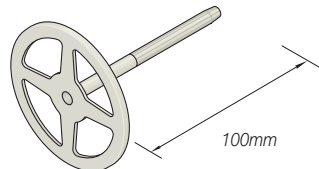

Debonding Sleeves

Debonded Ties require 100mm embedment. A 120mm long sleeve will provide an allowance for movement and tolerance, and will be suitable for most applications. Other lengths and sizes available to special order.



Wall Ties and Restraint Fixings

Installation Guidance

Wall ties are important to the stability of masonry and failure to install them correctly may lead to damp penetration, cracking or even the collapse of walls.

Wall ties should be pressed down in fresh mortar. They should be surrounded by mortar and not simply positioned directly onto masonry with mortar placed around them.

Ideally, ties should be installed with a slight fall to the outer leaf, not towards the inner leaf as this could provide a path for moisture to cross the cavity.

The drip part of the tie should point downward and be positioned near the centre of the open cavity. Ties with multiple drips, like the Staifix AMD, can often be positioned centrally as part of the drip will normally be near the centre of the open section of a partial fill cavity.

Installed ties should be clear of mortar droppings to allow the drip to function and prevent water from crossing to the inner leaf of masonry.

The practice of bending up installed wire ties should be discouraged. This can adversely affect the performance of the tie and weaken the embedment in the inner leaf. Rigid ties like the Ancon SD1 and ST1 should never be bent on site.

To ensure cavity wall ties are effective at tying the leaves together they should be installed as the inner leaf is constructed and not simply pushed into a joint. To encourage good site practice, all cavity wall ties which could be pushed into the mortar joints of a pre-constructed wall are manufactured with spread safety ends. If installed in this way the widest part of the safety end leaves a mark in the mortar each side of the tie.

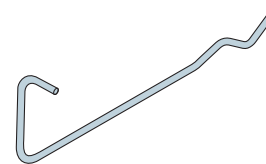

Staifix Safety End

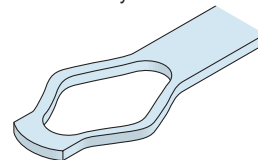

Ancon Spread Safety End

Ancon frame ties and channel ties are manufactured with a non-spread safety end allowing the use of a debonding sleeve. This type of safety end reduces the variety of ties required on site.

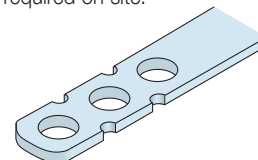

Ancon Non-Spread Safety End

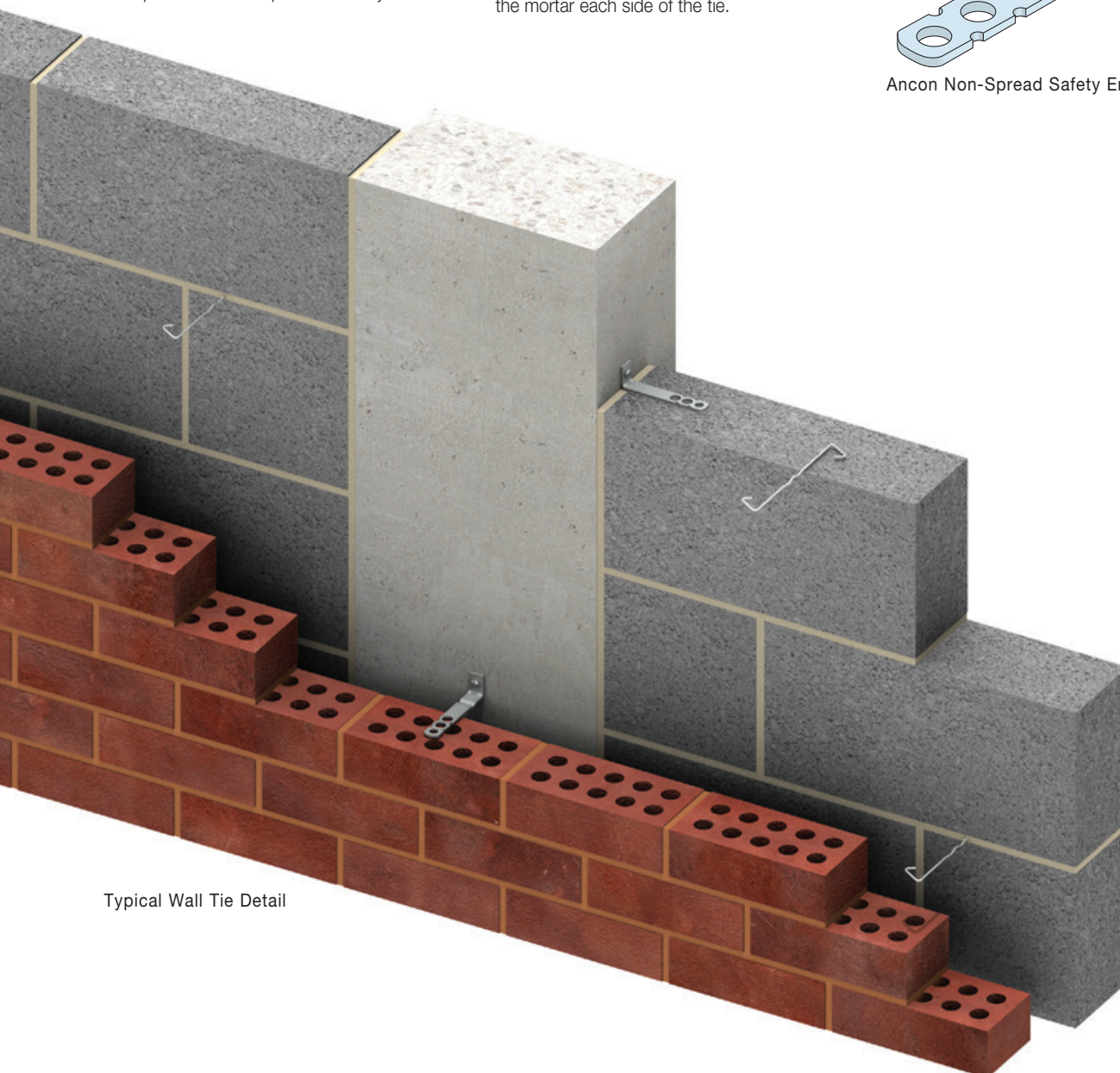

Typical Wall Tie Detail

Veneer Ties

Staifix AMD Veneer Tie (Type A Medium Duty)

The AMD Veneer Tie conforms to AS/NZS 2699.1:2000 as a type A medium duty classification. It is available in both 316 and 304 stainless steel. Grade 316 stainless steel covers durability exposure classification R2, R3 and R4. Grade 304 covers R2 and R3. The AMD Veneer Tie suits a cavity width of 50mm and is supplied with a fixing screw.

The AMD Veneer Tie is cranked to simplify installation and to prevent moisture from crossing the cavity. It should be positioned so the upstand is flush with the framework and an embedment of at least 50mm is achieved in the outer leaf where it is bedded on fresh mortar. The screw is installed through the hole in the upstand and the tie is built into the bed joint of the outer leaf of masonry.

The spacing of ties should be in accordance with building codes or engineers' specifications. There should be a minimum 15mm cover from any exposed surface.

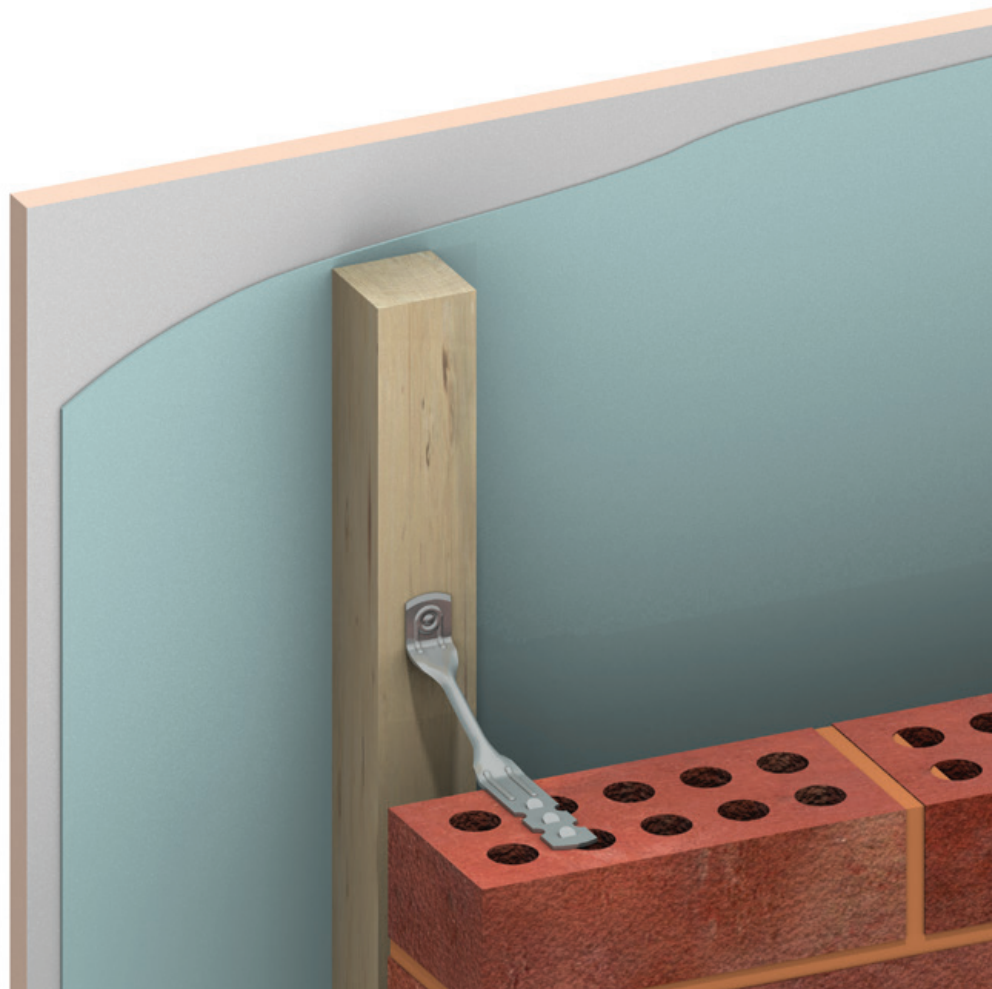

Staifix AMD Veneer Tie

Ties for Thin-Joint Blockwork

Helical TJ2 Wall Tie

The helical wall tie hammers directly into aerated concrete blocks, through insulation material, and is built into the bed joints of the outer leaf of brickwork. It is ideal for thin-joint blockwork and other applications where the joints in the inner and outer leaves are not aligned. Tools are available to simplify installation.

The black Staifix Clip is designed for use with these wall ties.



Helical TJ2 Thin-Joint Tie

Wall Ties and Restraint Fixings

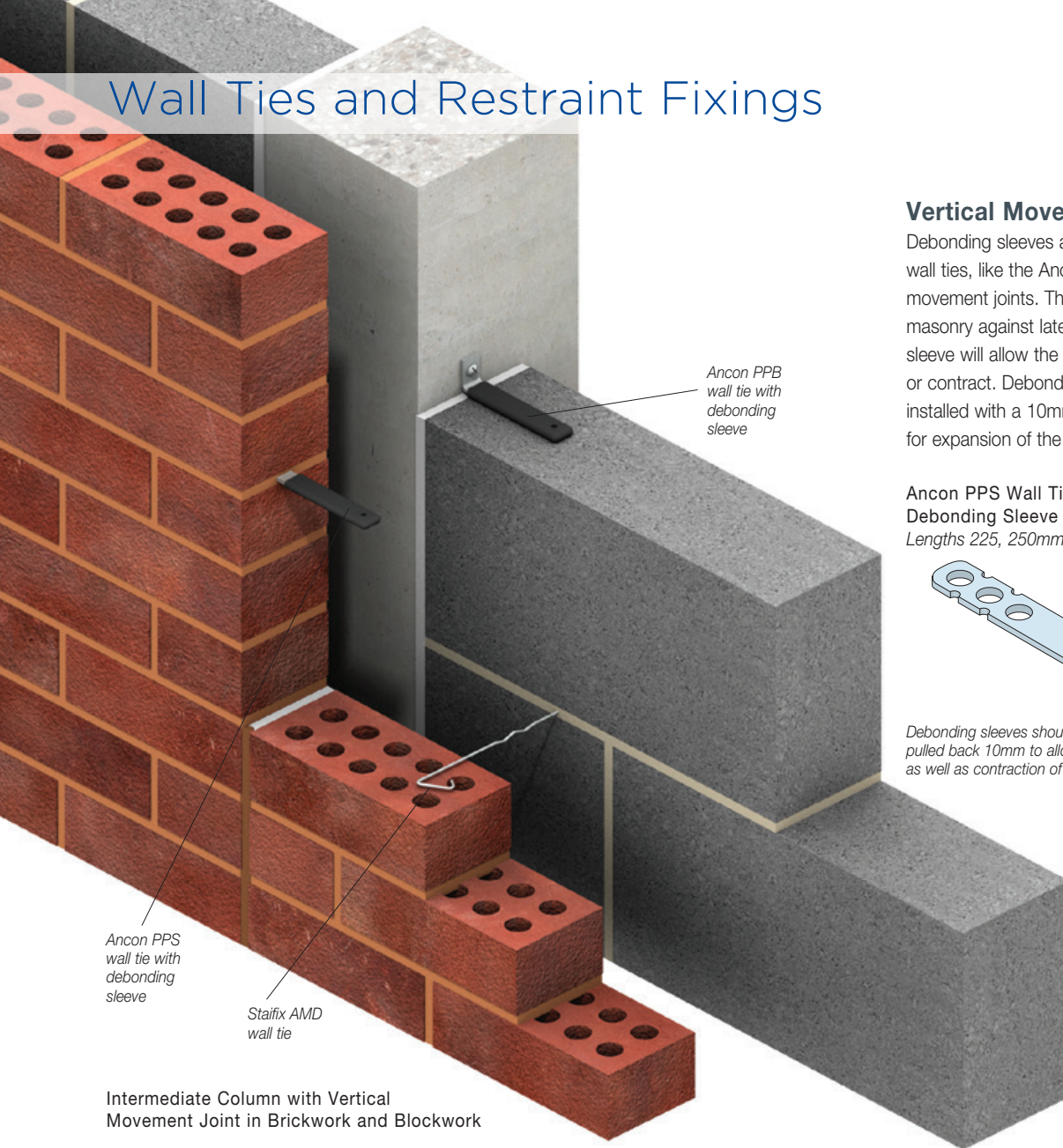

Vertical Movement Joints

Debonding sleeves are used on plain-ended wall ties, like the Ancon PPB, at vertical movement joints. The tie will restrain the masonry against lateral wind loads but the sleeve will allow the masonry to expand or contract. Debonding sleeves should be installed with a 10mm gap at the end to allow for expansion of the masonry.

Ancon PPS Wall Tie with Debonding Sleeve
Lengths 225, 250mm

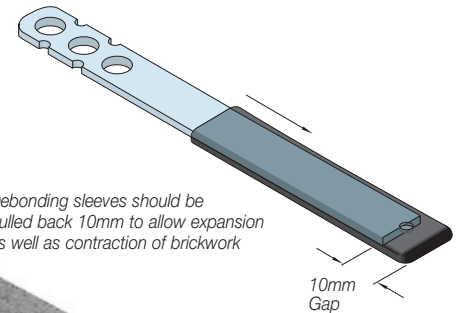

Debonding sleeves should be pulled back 10mm to allow expansion as well as contraction of brickwork

10mm Gap

Ancon PPS wall tie with debonding sleeve

Staifix AMD wall tie

Intermediate Column with Vertical Movement Joint in Brickwork and Blockwork

Staifix AMD wall tie

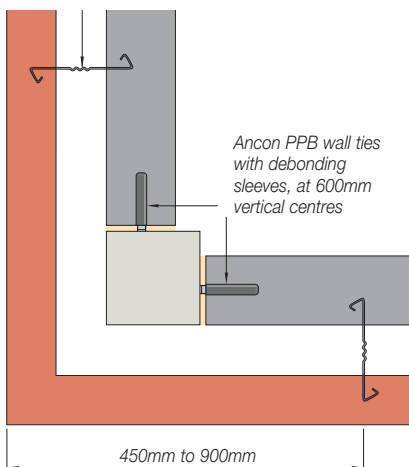

External Corner with Fully Bonded Brickwork

Ancon PPB wall ties with debonding sleeves, at 600mm vertical centres

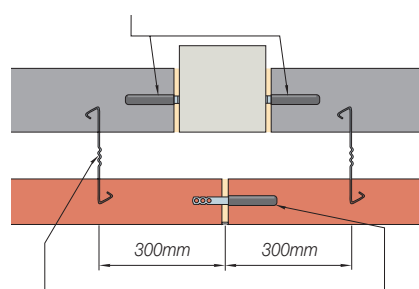

Staifix AMD wall ties at 300mm vertical centres in alternate courses to Ancon PPB Wall Ties.

Ancon PPS wall ties with debonding sleeves, at 300mm vertical centres

Intermediate Column with Vertical Movement Joints in both Brickwork and Blockwork

Ancon PPB wall ties with debonding sleeves, at 600mm vertical centres

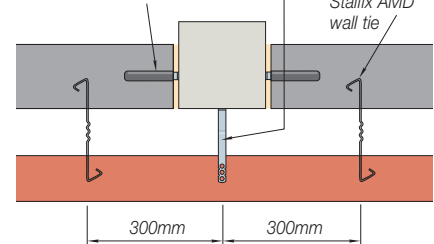

Intermediate Column with Vertical Movement Joints in Blockwork

Ancon PPS wall ties with debonding sleeves, at 300mm vertical centres

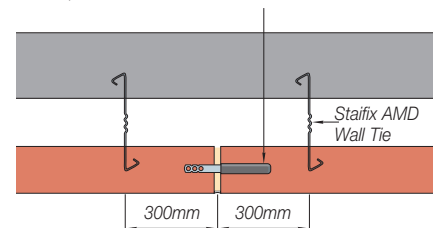

Cavity Wall with Vertical Movement Joint in Brickwork

Note: All spacings are maximums. The type of cavity wall tie and spacing will be determined by the cavity width, height of brickwork, wind loading and type of building. See page 7 for further information.

Ancon Frame Cramps and Channel Ties

Frame cramps can be fixed to concrete, steelwork or masonry and have a single 7mm diameter hole or an 8mm x 30mm vertical slot. Ancon M6 Single Expansion bolts are recommended for fixing to concrete, set screws or self-drilling screws for steelwork, and suitable plugs and screws for fixing to masonry.

Poor substrates will limit the capacity of frame cramps and site testing may be advisable in some cases. The performance will also be determined by the position of the fixing. SDV ties fixed to steelwork or concrete at the lowest point of the slot will have a safe working load of approximately 1kN. The capacity will reduce as the fixing is moved further away from the bend and greater movement must be expected than with other types of wall tie. Ancon SDB Frame Cramps have a safe working load of approximately 500N, comparable to the load of an SDV when fixed in the centre of the slot.

Ancon isolation sleeves and pads are supplied blank for use with self-drilling screws to isolate stainless steel frame cramps from mild steel. Self-adhesive isolation pads are also available for $_ _ B$ (20 x 30mm) and $_ _ V$ (25 x 50mm) referenced frame cramps.

Where masonry is in line with a column flange, frame cramps can be supplied with an offset angle section instead of an upstand. This angle allows the mechanical fixing to be suitably located. These ties are referenced SPA. They feature a 7mm hole as standard and can be used with a debonding sleeve if required at a movement joint. The thickness, size and shape of the angle section are designed to suit each application. Contact our Technical Department for more information.

Ancon ISO-TW Isolation Washer

The ISO-TW Isolation Washer has been designed for use with Ancon frame cramps referenced $_ _ V$ when fixing to steel frames. In addition to separating the dissimilar materials it allows cramps to be fixed to steel columns in advance of the masonry. Final adjustments to suit mortar joint levels can be made within the 30mm range of the slot without affecting the integrity of the fixing. The practice of pre-fixing frame cramps can speed the construction process.

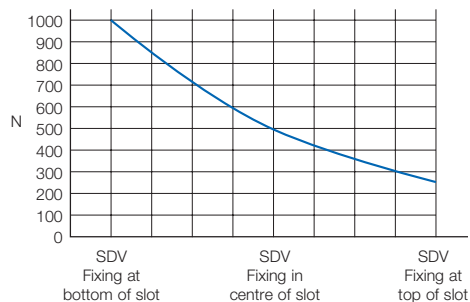
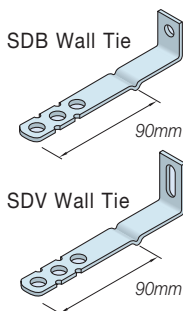

Recommended Safe Working Loads for 20 x 2.5mm Section Frame Cramps

Recommended Lengths of Frame Cramps and Cast-in Channel Ties

Cavity Width (mm)	Length of Wall Tie (mm)	Frame Cramp
20-44	100	SPB/SP21
45-69	125	SDB/SD21
70-94	150	SDB/SD21
95-119	175	SDB/SD21
120-144	200	SDB/SD21
145-169	225	SDB/SD21

Note: This table excludes Ancon Fastrack and Ancon 25/14 channels. Frame cramps should have a minimum embedment of 50mm in the outer leaf. Taking site tolerances into account, we suggest tie lengths which achieve a greater embedment.

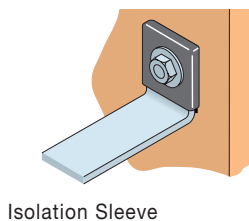

Isolation Sleeve

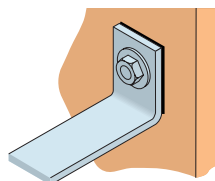

Adhesive Isolation Pad

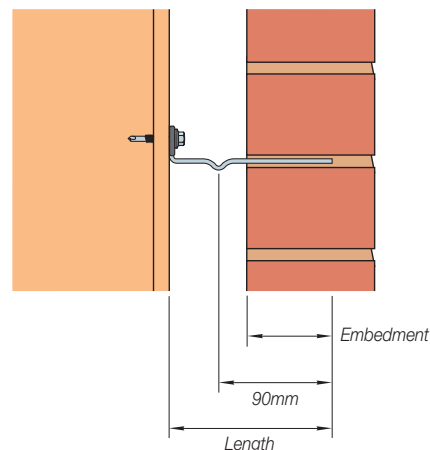

SDB Wall Tie Fixed to Steel with Self-Drilling Screw

Ancon SPA frame cramp at 450mm vertical centres

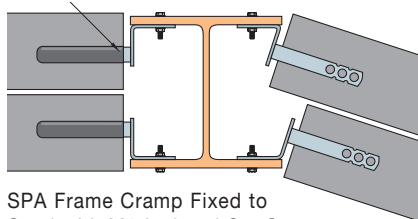

SPA Frame Cramp Fixed to Steel with M6 Isolated Set Screws

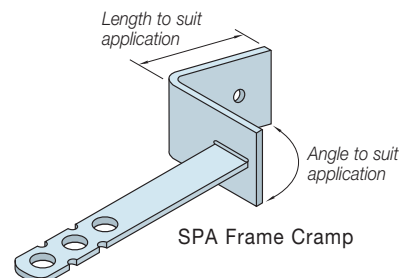

SPA Frame Cramp



Ancon ISO-TW Isolation Washer (Patent applied for)

Wall Ties and Restraint Fixings



Ancon 21/18 Omega Channel

Ancon 21/18 Omega Channel is a high performance, self-anchoring, cast-in channel slot suitable for use with Ancon wall ties to provide the necessary restraint to the outer leaf of masonry. The section is only 18mm deep and can be used where there is reduced cover to reinforcement. Available in 100mm and 3000mm lengths, Ancon 21/18 Omega Channel is filled with polystyrene to help prevent the ingress of concrete. Nail holes aid the fixing of the slot to timber formwork. Wall ties used with Ancon 21/18 Omega Channel will provide safe working shear and tensile loads of 1.5kN.

Ancon 25/14, 28/15, 30/20, 38/17, 36/8 and 40/25 Channels

Ancon wall ties can also be used with our 25/14, 28/15, 30/20, 38/17, 36/8 and 40/25 channels. 30/20 Channel is supplied with anchors for casting into concrete. 25/14 and 36/8 Channels are supplied plain-backed for surface fixing. 28/15, 38/17 and 40/25 Channels are available with or without anchors for casting in or surface fixing. Ties for 38/17 and 40/25 channels will be 25mm wide to accommodate the wider opening; all other channel ties will be 20mm wide. Wall ties used with Ancon 28/15, 30/20, 38/17 and 40/25 channel will provide safe working shear and tensile loads of up to 1.0kN, while wall ties used with 25/14 and 36/8 channels will provide up to 0.5kN. Maximum safe working loads of surface-fixed channels will be subject to suitable fixings, and appropriate fixing centres.

Available Lengths of Ancon 21/18 Omega Channel
100, 3000mm
U.K Patent No. 2 249 110

Ancon 21/18 Omega Channel with Ancon SD21 Tie

Fixing of Channel

Fixing Method	Omega 21/18	25/14	28/15	30/20	38/17	36/8	40/25
Cast-in	✓	✗	✓	✓	✓	✗	✓
Surface Fixed	✗	✓	✓	✗	✓	✓	✓

Maximum Centres for Surface-Fixing

SWL (tension)	25/14	28/15	38/17	36/8	40/25
0.5kN	337	525	650	300	650
1.0kN	-	400	525	-	525

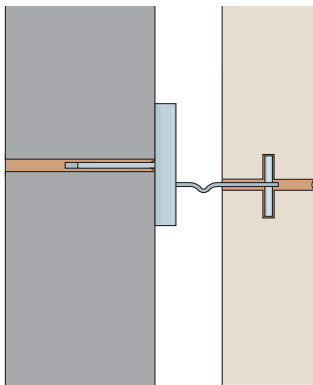

Fastrack used with DD28 Tie for Stonework

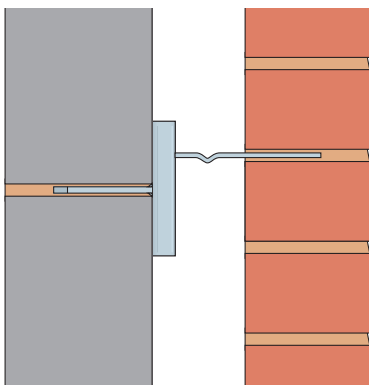

Fastrack used with SD28 Tie for Brickwork

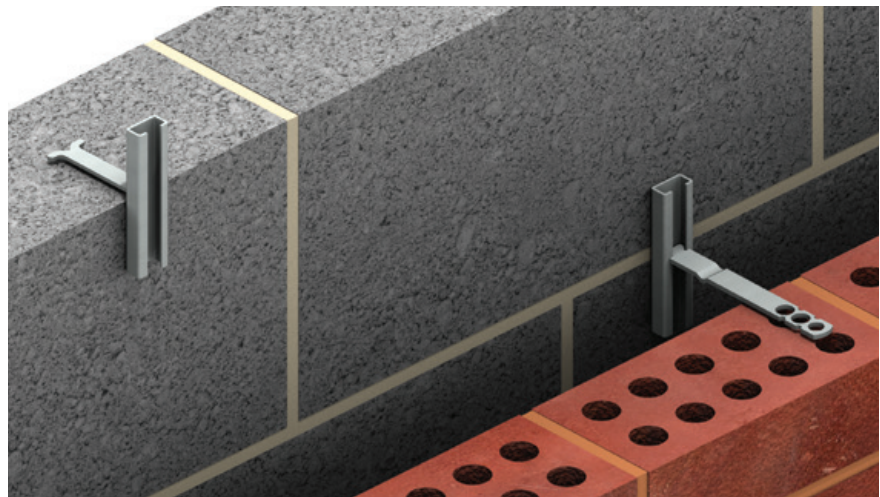

Ancon Fastrack Channels 100mm long with SD28 Tie

Ancon Fastrack

Building one leaf of the cavity wall in advance of the other is often beneficial but can create problems with coursing. Buildings which incorporate imperial or continental bricks and standard metric blocks present even greater difficulties.

Ancon Fastrack Channel is built into the inner leaf of blockwork ready to take an Ancon SD28 or similar tie for the outer leaf. This method of construction avoids the dangers of projecting ties.

Ancon Fastrack Channels and Ties can be supplied in different lengths and can also be used for tying stonework to blockwork if DD28 or similar Ancon Ties are used.

Ancon Fastrack Channels and Ties sustain loads which exceed the requirements for a Type 2 tie to PD 6697. This system can also be manufactured in a 36/8 channel profile that accepts wall ties referenced __ 36.

Ancon Two-Part Tie

Cavities exceeding 150mm are sometimes required. This necessitates longer ties which can be difficult to balance and keep horizontal when built into the inner leaf. The Ancon Two-Part Tie has one section built into the blockwork; the other section is then fixed as the outer leaf is built. An embedment of 75mm is required at each end. The inner tie is usually manufactured in lengths of 170mm with variation in the cavity width being accommodated by the length of the outer section. Where insulation thickness is in excess of 60mm, the inner section should be longer than the standard 170mm to ensure the connection between the two parts is made in the open cavity. Insulation Retaining Clips can be supplied to fit the inner section.

Ancon Two-Part Ties sustain loads which exceed the requirements for a Type 2 tie to PD 6697 for cavities up to 300mm. Type 2 performance can be achieved for wider cavities providing the fixing centres are adjusted in accordance with the table below.

To specify or order this tie simply quote 'Ancon Two-Part Tie to suit ___mm cavity with an insulation thickness of ___mm'.

Recommended Fixing Centres for Two-Part Ties

Cavity (mm)	Vertical centres (mm)	Horizontal centres (mm)
150-300	450	900
301-333	450	750
334-367	450	600
368-400	450	450

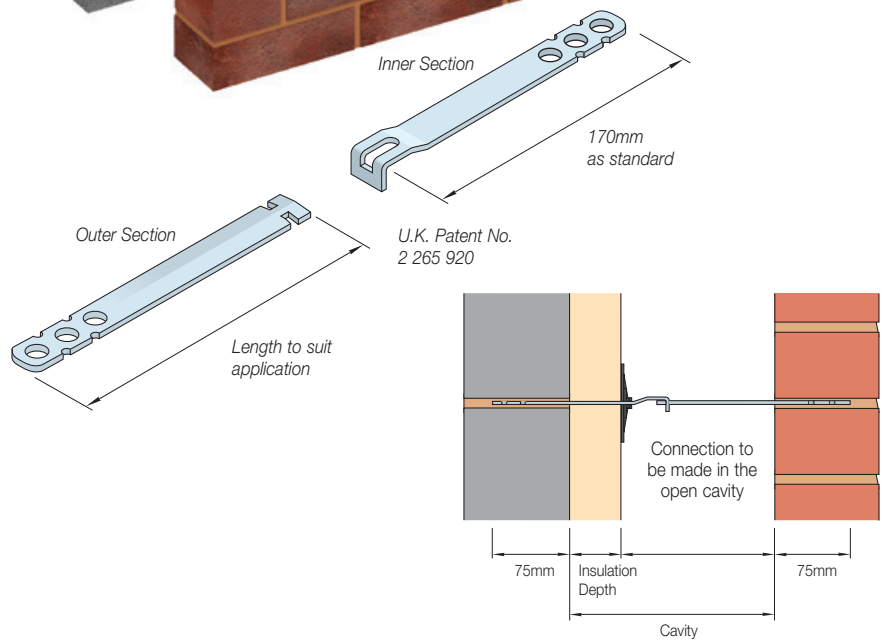
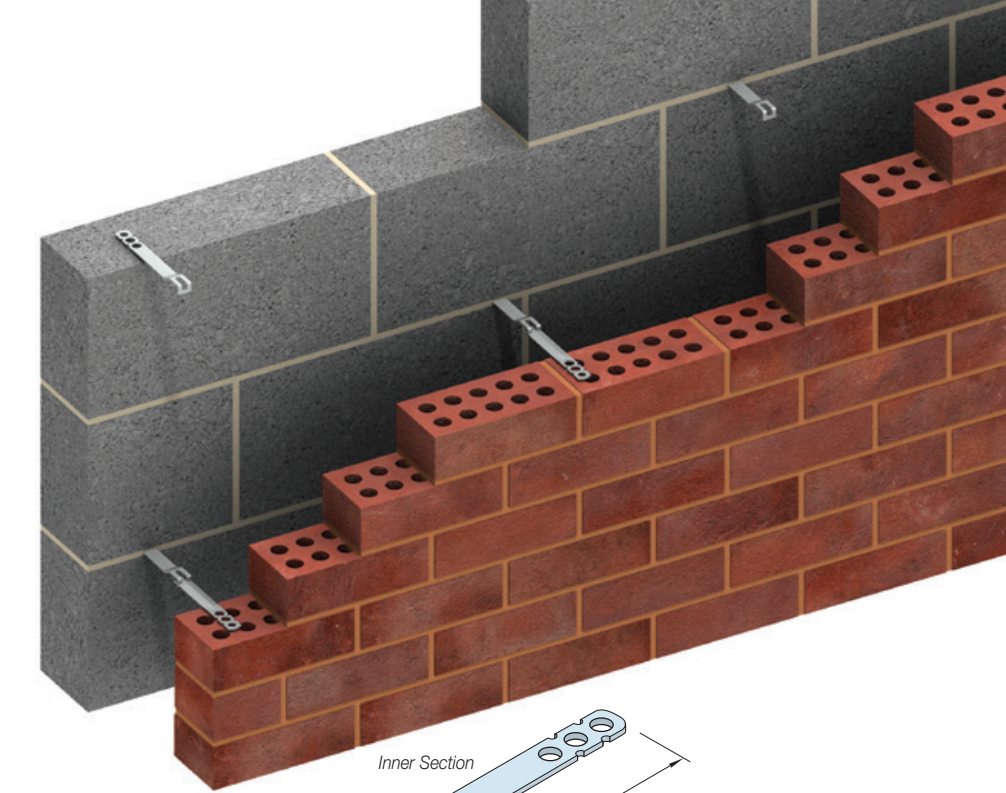

Wall Starter Systems

36/8 Wall Extension System

The 36/8 Wall Extension System can be supplied with either SP36 ties or, where some longitudinal movement must be accommodated at the joint, PP36 ties complete with debonding sleeves. The channel can be supplied in lengths of up to 3.4 metres with each length having a series of holes to allow fixing to the existing wall. The system is available as a kit comprising a length of 36/8 channel 2400mm long, ten ties and ten plugs and screws.

Staifix Universal Wall Starter System

This system includes all necessary fixings to join a single skin of masonry, 2400mm high, to an existing wall. Each pack includes 2 fixing strips, 5 plugs, 5 washers, 5 screws and 10 wall ties. Suitable for wall widths from 60mm to 250mm and masonry up to 8 metres in



36/8 Wall Extension System, PP36 Tie

height, this system will resist a wind load of up to 4.0kN over a height of 2400mm. Wall Ties slide within the channel to course with the bed joints of any masonry unit.



Staifix Universal Wall Starter System

Wall Ties and Restraint Fixings

Restraints for Stone Cladding

Reference should be made to BS 8298 : 1994 "Design and installation of natural stone cladding", when selecting ties for restraining stone cladding. Restraints should be designed to resist wind loads and any imposed loads from, for example, window cleaning equipment.

Each stone will normally be restrained in four places, two at the top and two at the bottom. These are usually situated in the horizontal joints. The restraints should be located in pre-formed mortices or holes positioned in the centre of the thickness of the stone panel, and located at 1/4 points for half bonded stones and 1/5 points for stack bonded stones. Restraints should be kept at least 75mm from any corner with the peripheral distances between any two restraints not exceeding 1200mm.

The embedment of restraint dowels and lips into the stone should be at least 20mm. To achieve this, lipped ties (LPBs) have a 25mm downstand and dowelled ties (DPBs and YPBs) have 60mm long dowels.



Ancon YDB Ties Fixed to Blockwork

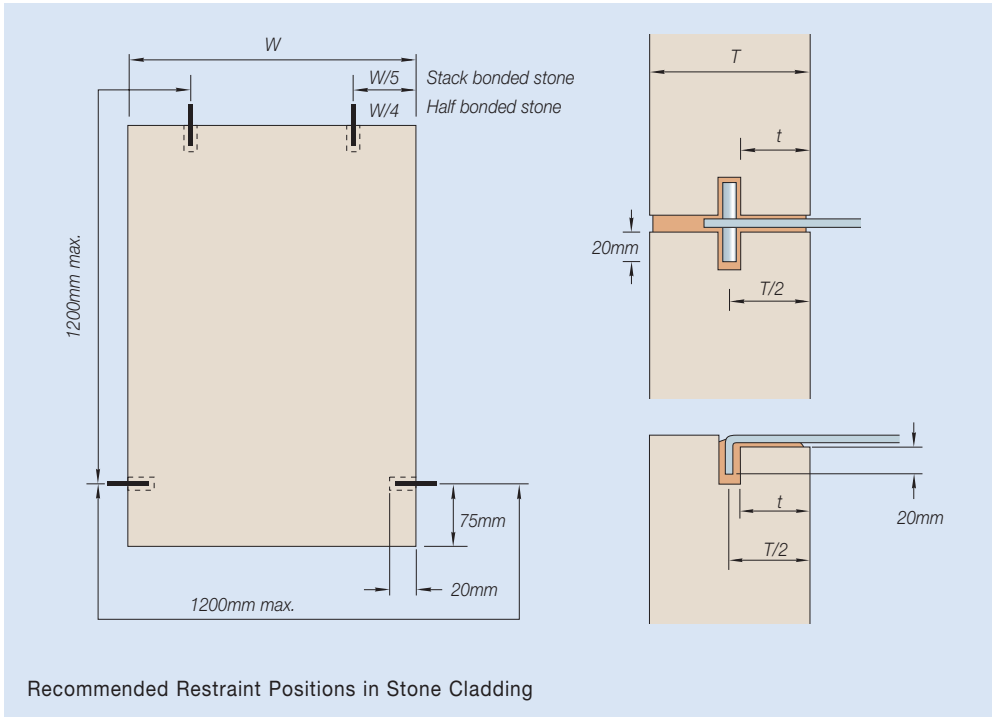

Minimum Stone Thickness 'T' and Minimum Dimension Behind Restraint 't'

Type of Stone	More than 3.7m above ground - including facias		Soffits - including inlined soffits		Sills, copings and supported reveals	
	T (mm)	t (mm)	T (mm)	t (mm)	T (mm)	t (mm)
Granite, slate, white marble, quartzites	40	15	40	15	30	12
Hard limestone, travertines	40	15	40	15	30	12
Limestone, sandstone	75	30*	75	30*	50	20*

* t = T/2 if stone thickness (T) is greater than 75mm

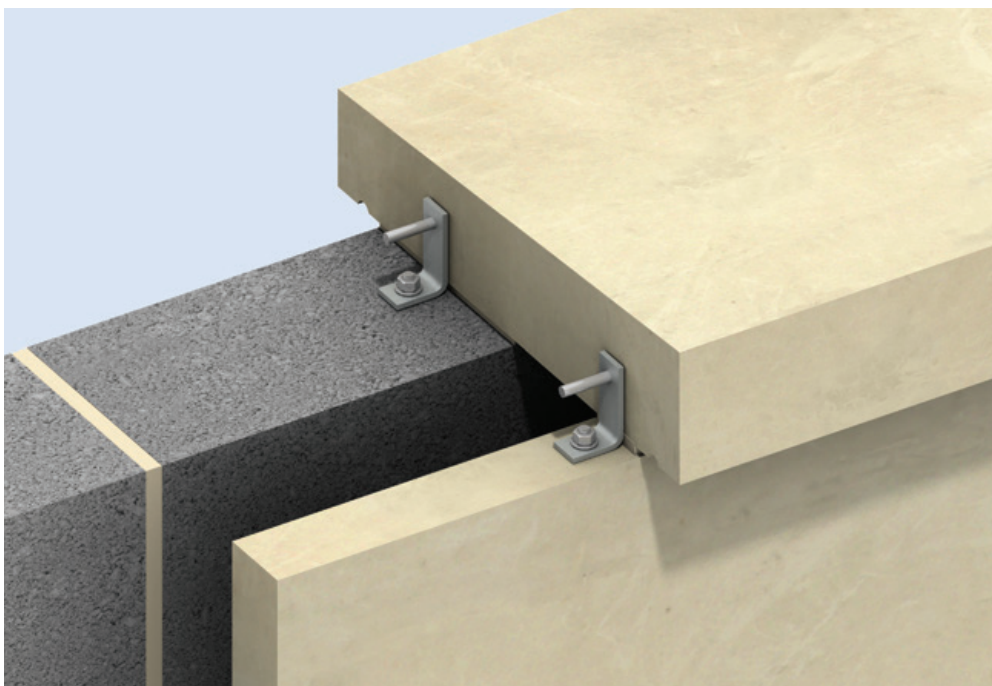

Two Ancon YPB Ties Restraining Coping Stone

Wall Ties and Restraint Fixings

Section of Ties

Minimum sections for restraints for various thicknesses of stone are shown in the table below. Restraints for large stones and for use where cavities are in excess of 100mm may require special attention. They may need a much bigger section than 20 x 2.5mm; ties formed from 20 x 3mm, 25 x 3mm, 30 x 3mm and 30 x 4mm are frequently used for restraining stone cladding.

Minimum Section of Restraints

Stone Thickness	Minimum Section of Restraint
30mm and below	3mm dia wire
40mm	5mm dia wire
50mm and above	20 x 2.5mm

Drip Position

Due to the wide varieties of design cavity and stone and insulation thickness it is not possible to standardise the position of any required drip. If a drip is required (e.g. YDB) please specify the position clearly, indicating from which end of the tie the measurement is taken.

Dowels

Standard dowels are 6mm in diameter and 60mm long. These will be welded into the tail end of ties referenced D__, and supplied loose with ties referenced Y__ and the multi-holed M___. 8mm and 10mm diameter dowels are also available and will usually be supplied where larger section ties are required.

Wire Ties

The traditional method of fixing thin marble, particularly for internal linings and low rise cladding is with wire ties and plaster or mortar dabs. Wire ties are manufactured from 3mm and 5mm diameter wire.

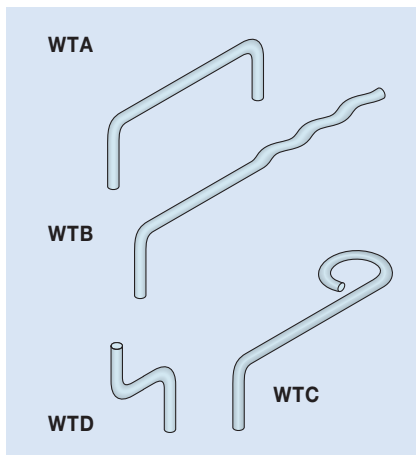

Ancon LDB Ties Fixed to Backing Structure, Restraining Top of Stone

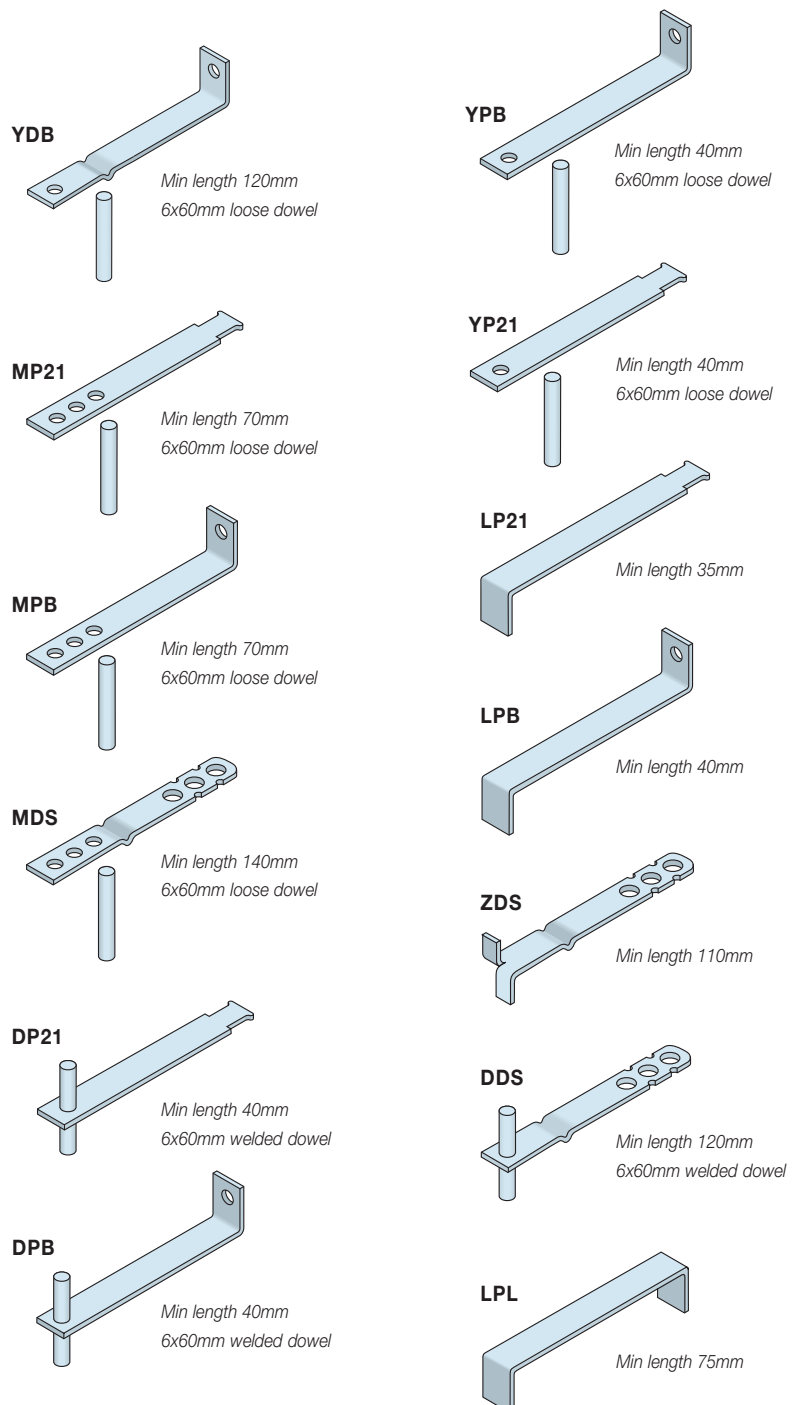

Ancon 150

The Ancon 150 is a grout-in masonry tie for the restraint of 20 to 30mm thin facings, and suitable for cavities up to 60mm wide. The 12 x 2mm corrugated body provides optimum bond in a 12 x 90mm hole. The 50 x 3mm dowel is supplied loose.

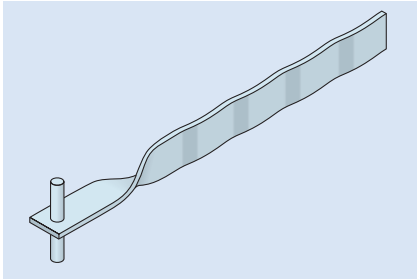

Ancon 150



Ancon 2000

Ancon 2000 restraint fixings are a simple and secure method of fixing thin facing slabs. The fixing is quickly and easily installed with the small diameter hole giving lower drilling costs and minimum disturbance to the structure. Vertical and lateral adjustment is provided by the slotted holes in the fixing clip.

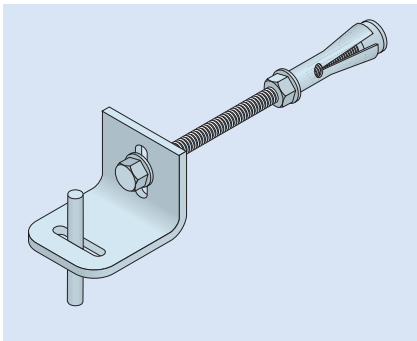

Ancon 2000

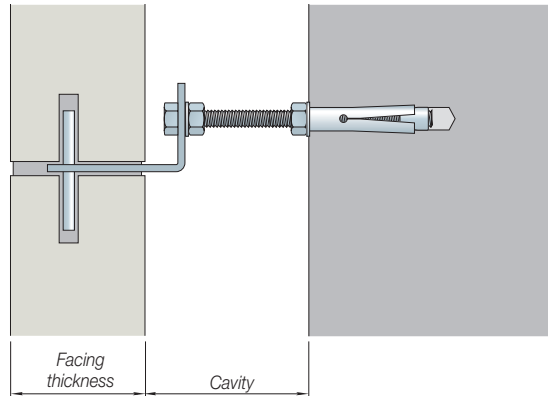

Ancon 2000 Thin Facing Restraints

Reference	Facing Thickness (mm)	Cavity Min. (mm)	Max. (mm)	Hole Size (mm)	Dowel Size (mm)	Safe Working Load* (N)
2000/A	20	25	70	8 x 90	4 x 60	600
	25	22	67	8 x 90	4 x 60	600
2000/B	30	30	75	8 x 90	4 x 60	600
	40	25	70	8 x 90	4 x 60	600
2000 - 75	20	60	105	8 x 90	4 x 60	600
	25	57	102	8 x 90	4 x 60	600
	30	55	100	8 x 90	4 x 60	600
	40	50	95	8 x 90	4 x 60	600

Other sizes available to order. *In grade 30MPa concrete

Wall Ties and Restraint Fixings



Ancon IHR - B Bolted to Concrete, Restraining Top of Inner Block Wall

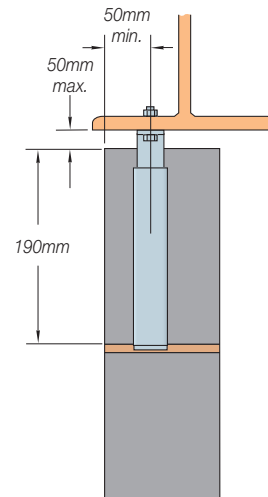

Ancon Head Restraints

Ancon Head Restraints provide the necessary restraint to the top of masonry walls. They allow for vertical movement to accommodate shrinkage or thermal movement of the wall or structural frame, while restraining wind loads.



Ancon IHR - C Restraining Top of Inner Block Wall to 38/17 Channel Cast into Concrete

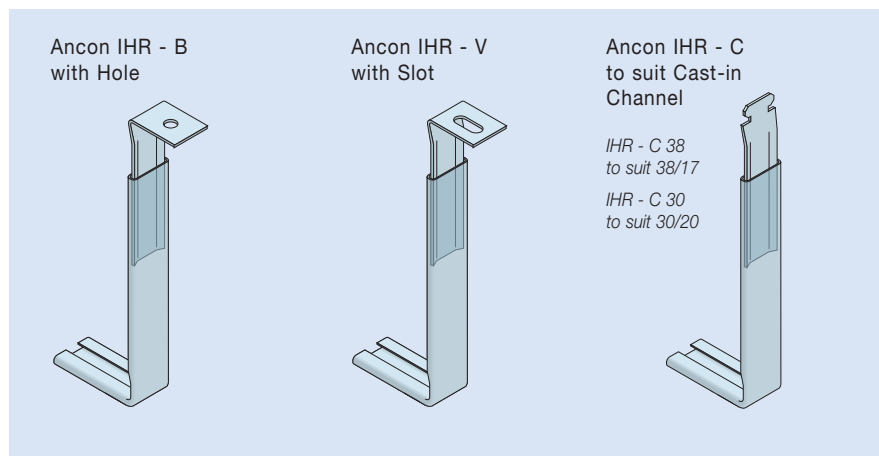

Ancon IHR - Internal Head Restraint

The Ancon IHR is used for restraining the top of internal walls or the top of the inner leaf of a cavity wall. The opening at the front of the channel stem is sealed to prevent mortar ingress and to ensure that vertical movement can take place between the blockwork and the structure. The base of the stem must be built within a bed joint with the centre of the stem no closer than 50mm from the edge of the block. The vertical joint should be filled with mortar each side of the stem. The maximum joint between the top of the blockwork and the underside of the frame is not normally greater than 25mm. The standard Ancon IHR will suit a 215mm high block and can resist a load of 1.5kN. Where the gap at the top increases from 25mm to 50mm, the working load is reduced from 1.5kN to 1.0kN. Other sizes between 150 - 250mm are available.

The sliding tie can be provided with either a hole (IHR - B) or slot (IHR - V) to suit M8 bolts, or with a notch end to fix directly into a 38/17 or 30/20 cast-in channel (IHR - C).

Ancon FHR - Head Restraint

The Ancon FHR Head Restraint is used for restraining the top of internal walls or the internal leaf of a cavity wall. The two angles clamp the top of the wall and have 10mm diameter holes to suit M8 bolts. They are supplied with two holes in the longer angle to allow the restraint to fit 100mm and 140mm blockwork. Each restraint can resist a service load of 1kN.

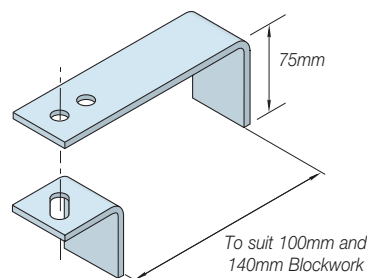

Ancon FHR Head Restraint - other sizes available

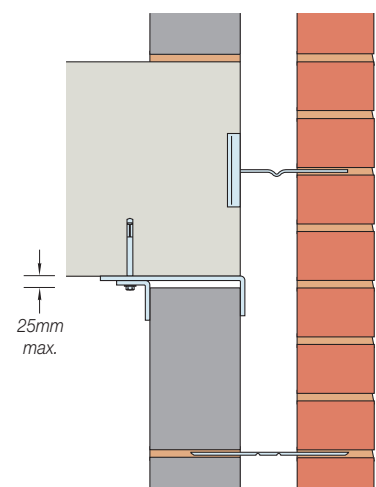

Ancon FHR Head Restraint Fixed to Underside of Floor Slab, Restraining Head of Inner Leaf of Cavity Wall

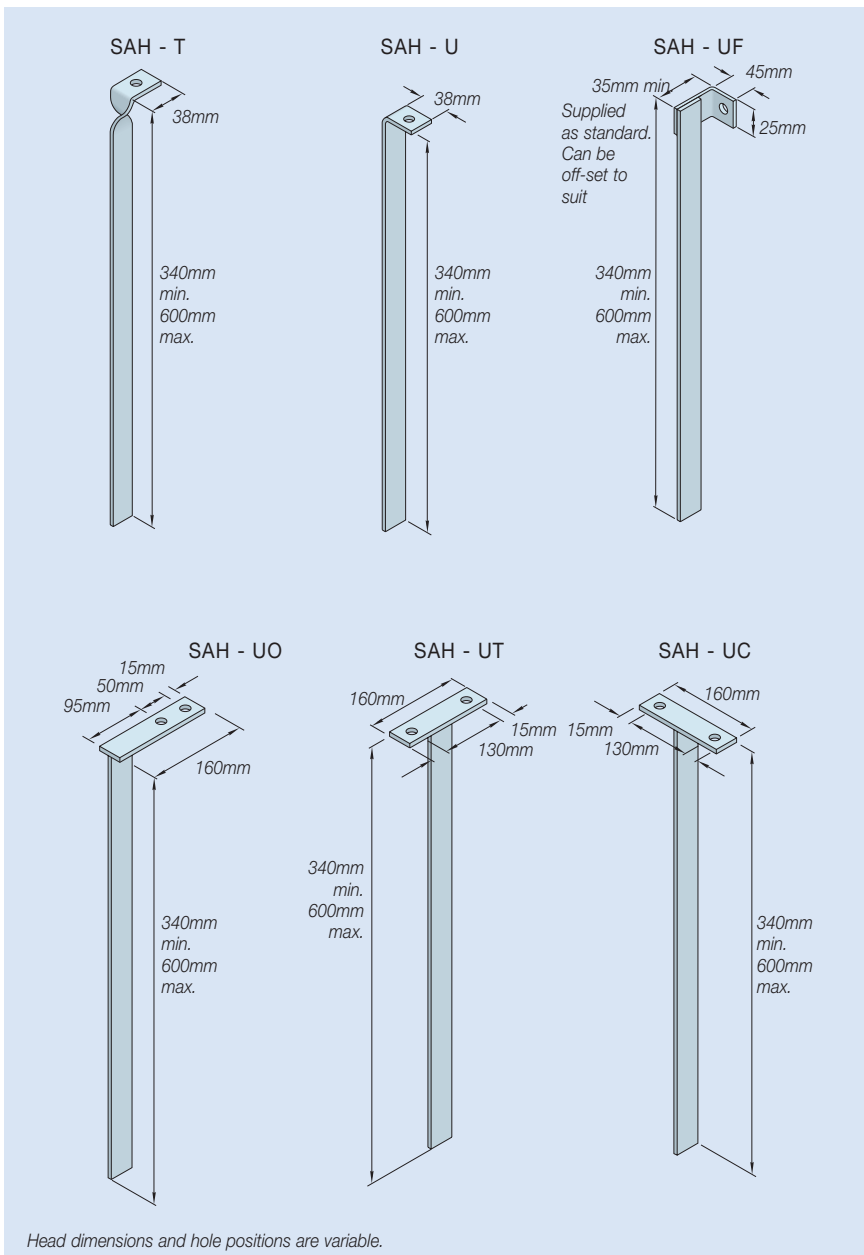
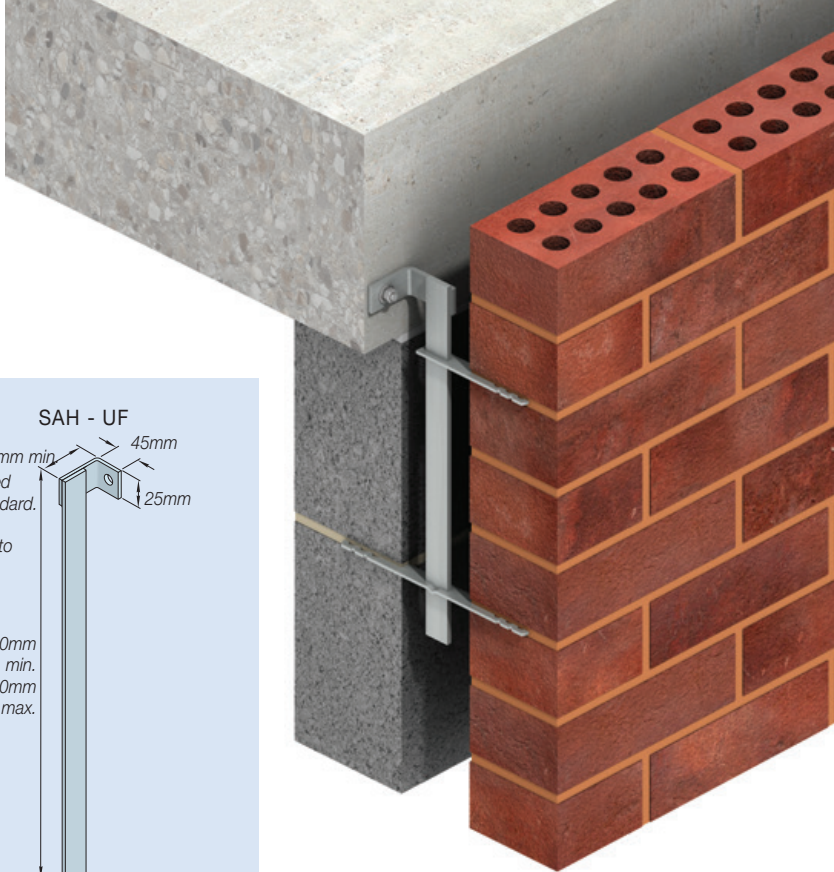

Ancon SAH - Sliding Anchors

Ancon SAH Sliding Anchors have stems which fit within the cavity and accept ties that slide to accommodate vertical movement. Available with six different head options as standard, they are supplied with one-way or two-way ties with safety ends.

The standard fixing hole is 12mm diameter to suit Ancon M10 Single Expansion Bolts or M10 T Head Bolts to fit Ancon 28/15 Channel. Ancon SAH Sliding Anchors have 25 x 5mm stems and a maximum service capacity of 1kN per stem when the upper tie is within 75mm of the fixing. Ties should be spaced at a minimum of 150mm and at least two ties should be used per stem.

These drawings are examples only. All sliding anchors are manufactured to suit individual requirements.

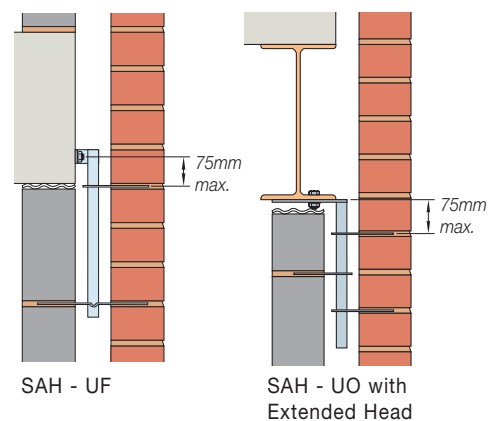
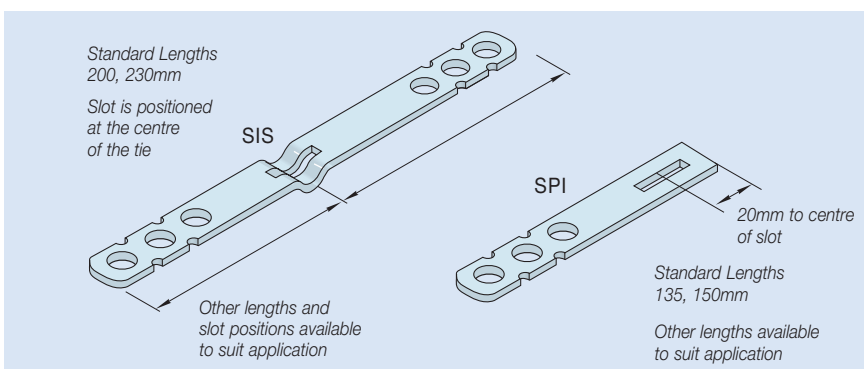

Ancon Wall Ties to suit SAH Sliding Anchors

Wall Ties and Restraint Fixings

Remedial Wall Ties

Corrosion of Cavity Wall Ties

Wall ties are an essential element in the stability of masonry panels. Traditionally, wall ties were manufactured from galvanised mild steel. These ties were expected to last the lifetime of the building, but for many years it has been recognised that some of these wall ties have corroded after only 15 or 20 years.

When these ties corrode, they can expand to seven times their original thickness. This causes the brickwork to crack at the mortar joints and can result in major damage and sometimes the collapse of walls.

It is crucial that the problem is identified as quickly as possible and the correct remedial action undertaken.

Ancon 63 Range

This is the original remedial wall tie which has been used in various forms since 1972. The Ancon 63 range has been continually improved to keep pace with changing requirements. These ties are easy to install and a secure fixing is achieved with a minimum amount of disturbance.

Highly corrosion-resistant materials are used throughout the 63 range. The grade 304 stainless steel body of the MM 63 has expansion shells at both ends for installation into a 10.5mm diameter hole. A neoprene ring prevents moisture travelling past the centre of the tie.

Test Results

The '63 ties have been tested independently in a variety of materials using the standard '63 tie, a summary of results is given in the table. The failure loads noted in the table are obtained from standard tests in brick couplets and provide indicative values of tie performance. The couplet test produces results of a conservative nature compared to actual wall tests. Due to the variability of materials, it is often prudent to undertake a pull-out test on site, to verify the selection of an appropriate tie.

Spacing

No Standard has yet been defined for the spacing of remedial wall ties. However, accepted practice is to follow AS 3700.

Installation of Remedial Wall Ties

Mechanical ties are easily installed by means of two Setting Tools. The tie is fitted to the setting tool for the inner leaf and inserted into a pre-drilled hole in the wall. The required drill depth for each tie is shown in the table below. The inner shell is expanded by turning the handle. The tool for the outer leaf, with a hexagonal-shaped end, is then fitted and adjusted to expand the outer shell. Both tools should be turned until hand tight. The process is quick and simple and ensures that each tie is correctly installed.

To install Staifix Resin/Resin and TeploTie (Type 2) remedial wall ties an extension nozzle and tube is required to pump resin across the cavity and into the inner leaf. The extension tube is supplied in a standard length of 1000mm and is cut to suit on site.

Ancon 63 Setting Tools

Setting Tool - Outer



Setting Tool - Inner



Drill Depths

Cavity Widths (mm)	Tie Lengths (mm)	Drill Diameter (mm)	Drill Depths (mm)
50-70	200	10	60 min.
71-95	225	10	60 min.
96-125	250	10	60 min.
126-175*	300	10.	60 min.

*or where greater embedment is required.

Note: For cavities over 100mm horizontal spacing may need to be reduced to 450mm.

Failure Loads (Pull-Out) for the Ancon 63 Range

Base Material	Compressive Strength (MPa)	Failure Load (kN)
Hard Brick	80	5.6
Soft Brick	30	3.8
Portland Stone	20	5.3
Concrete Block	7	1.9

Note: Test results are an average of 20 No ties.

Failure Loads (Pull-Out) for Staifix R/R

Base Material	Compressive Strength (MPa)	Failure Load (kN)
Dense Concrete Block	7.0 - 10.5	5.78
Lightweight Concrete Block	2.8 - 3.5	2.87
Mortar Bed Joint, 1:1:6 Type (iii) PD 6697	-	5.37

Ancon 63 Mechanical/Mechanical

Used when tying together two leaves of solid materials, this tie has mechanical expanders at each end. Requires 10mm holes.

Ancon 63 Resin/Mechanical

For use when the material in the inner leaf is perforated, of low-density or a friable material. A resin fixing may be used to eliminate any imposed stress. Requires 10mm holes.

Staifix Resin/Resin

Used where mechanical expanders are unusable. Normally inserted into a 10mm hole, but if test facilities are required, a 12mm hole must be used.

A plastic sieve can be used to retain resin and is particularly useful in perforated brick or hollow blockwork. A 12mm hole is required to fit the sieve.

Stairib Bar

Stainless steel ribbed bar, resin-grouted into the inner and outer leaves. Requires 10mm hole (6mm dia. bar) or 12mm hole (8mm dia. bar).

Ancon AC 31

Used where bricks are removed then replaced in the outer leaf. The wavy end is resin-bonded into the inner leaf in a 10mm hole. The triangular end sits in the bed joint. Ancon AC 31 can be supplied with a drip or a neoprene ring.

Ancon AC 31C

Similar to the AC 31 but cranked by 25mm to aid fixing to the inner leaf. Requires 10mm holes.

Cameron T 47

Used for the repair of mass brickwork with an unbonded brick façade, sometimes built from snapped headers. The T end is built into the bed joint and perpendicular, and hidden when the brickwork is repointed. Requires 12mm holes.

fischer FIS P Resin

This styrene-free injection resin is quick setting and suitable for a wide range of applications. The two components are safely mixed together inside the nozzle. Automatic mixing ensures an accurate blending of the components and, being mixed only as required, the minimum of wastage. Resin guns and additional mixing nozzles are available.

Setting Times for FIS P

Temperature (°C) in Substrate	Setting Time
- 5	360 mins
0	180 mins
+ 5	90 mins
+ 20	45 mins
+ 30	30 mins
+ 40	25 mins

Ancon MM 63
 200mm for 50-75mm cavities
 225mm for 76-100mm cavities
 250mm for 101-125mm cavities
 300mm for 126-175mm cavities

Ancon RM 63
 200mm for 50-75mm cavities
 225mm for 76-100mm cavities
 250mm for 101-125mm cavities
 300mm for 126-175mm cavities

Staifix R/R
 180mm for 40-60mm cavities
 200mm for 61-80mm cavities
 220mm for 81-100mm cavities

Stairib Bar
 Length to order
 6, 8mm dia.

Ancon AC 31
 Lengths 175, 200, 225mm

Ancon AC 31C
 Lengths 175, 200, 225mm

Cameron T 47
 Lengths 200, 250, 300mm 4.7mm dia.

Wall Ties and Restraint Fixings

Masonry Reinforcement

Ancon AMR is used to improve the structural performance of masonry walls by providing additional resistance to lateral loads e.g. wind. It can also be used to reduce the risk of cracking either at stress concentrations around openings or as a result of movement.

Available in various standard configurations, the Ancon AMR suits a wide range of structural load conditions and wall widths.

The longitudinal wires have a minimum characteristic yield strength of 500MPa.

Widths

Available in four standard widths (60, 100, 150, 175mm), the Ancon AMR can be used in wall widths from 100mm to 215mm.

Applications & Product Width

Brick/Block Thickness	AMR Width
100mm-125mm	60mm
140mm-150mm	100mm
190mm-200mm	150mm
215mm	175mm

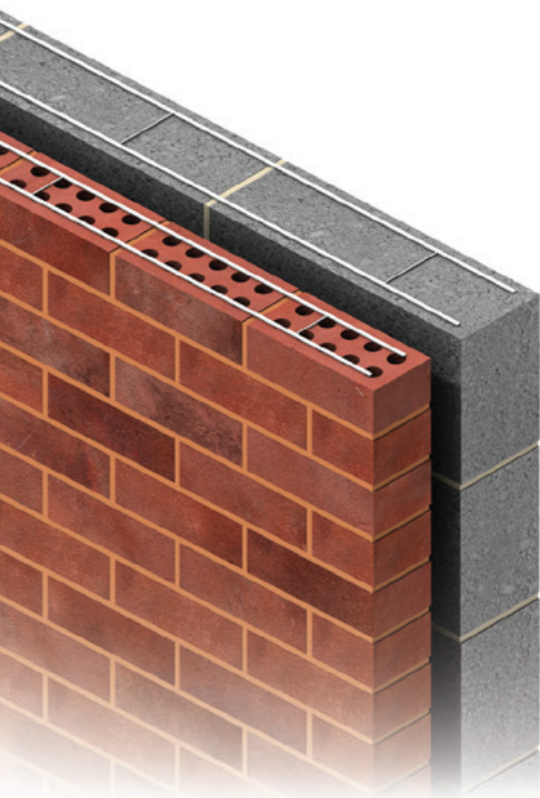

Wire Diameters

The Ancon AMR is manufactured from five wire sizes which, after flattening, have an equivalent wire diameter of 3.0, 3.5, 4.0, 4.5, and 5.0mm. This range suits the majority of load conditions.

Materials

Ancon AMR is available in Austenitic stainless steel (ref. S) and galvanised steel (ref. G). Stainless steel provides the greatest corrosion resistance and life-cycle costing benefits, and is suitable for use in any application. Galvanised steel is not suitable for use in the external leaf of a cavity wall.

Depth

The main longitudinal wires are flattened to less than 3mm. These wires are joined by cross wires welded in the same plane at 450mm centres. This profile ensures good mortar cover is maintained, even when the product is lapped or used with wall ties.

Length

Ancon AMR is manufactured in standard lengths of 2700mm.

Product Identification

Each length of AMR is marked with a product reference.

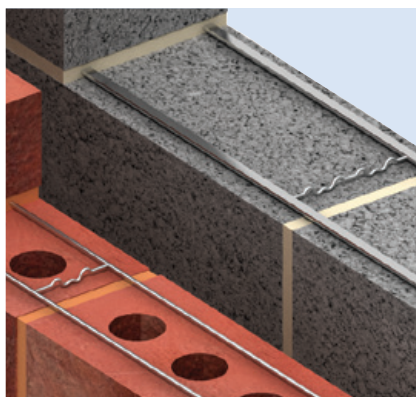

Now available: Ancon AMR-X Masonry Reinforcement. Shaped cross-wires ensure the longitudinal wires are located in the centre of a bed joint and are completely surrounded by mortar. Contact us for more information.

Corners

Prefabricated corner units can be manufactured to provide true continuity of reinforcement. Alternatively, Ancon AMR can be cut and bent on site.

Laps and Positioning

Laps should be a minimum of 225mm in length and can be achieved by either stacking the product or positioning lengths side by side. The position of laps should be staggered throughout the masonry panel.

Positioned side by side

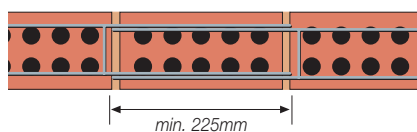

Stacked

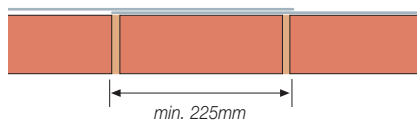

Overall thickness when lapped is less than 6mm

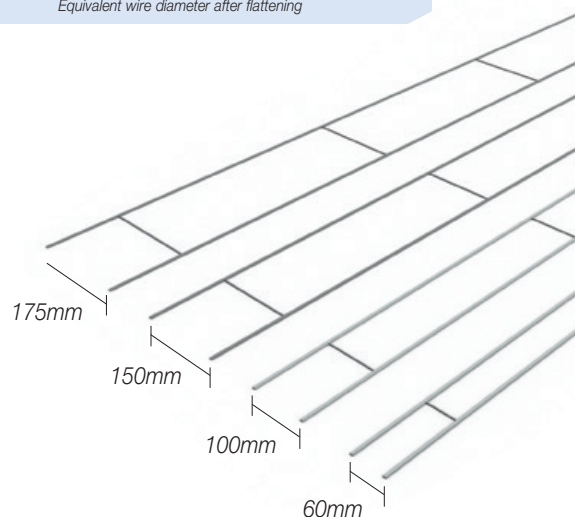

AMR is manufactured to the requirements of BS EN 845-3:2003

Applications



Sydney Park Village, Sydney, NSW



Trinity Apartments, St Leonards Sydney, NSW



UNSW Lodge, Kensington, Sydney, NSW

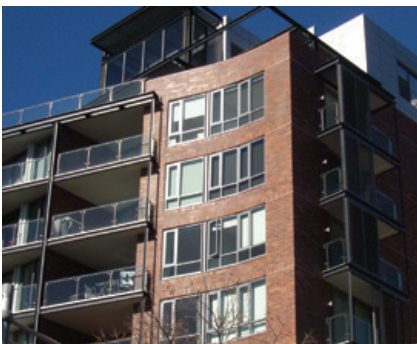

Walsh Bay, Sydney, NSW



Breakfast Point, Mortlake, Sydney, NSW

Other Ancon Products

Masonry Support Systems

Masonry cladding on concrete or steel frames is normally supported from stainless steel support systems. Ancon MDC Systems create a continuous angle to support the outer leaf of masonry. Ancon Individual Brackets support masonry features such as curves and arches. A full design service is available to specifiers and users of Ancon systems.

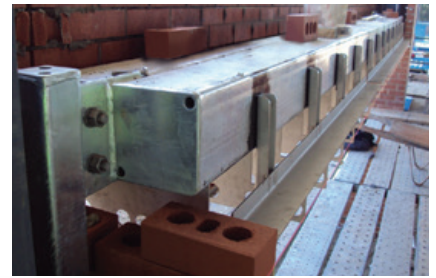

Windposts and Parapet Posts

Large panels of masonry or panels with openings can often be difficult to justify structurally. Ancon Windposts span vertically between floors to provide additional lateral support. The Ancon WP2 is an angle section windpost. One leg of the angle is built into the masonry and ties are passed through the post to minimise movement. Debonded ties can be used if the post is positioned at a movement joint. Ancon Windposts are manufactured from stainless steel and are supplied complete with all ties and end connections.



Channel and Bolt Fixings

Leviat offers a wide range of channels and bolts in order to fix stainless steel masonry support, restraints and windposts to structural frames. Cast-in channels and expansion bolts are used for fixing to the edges of concrete floors and beams. A range of stainless steel set screws and self-drill self-tap screws are designed to fix to steel frames.



Tension Systems

Tie bars are increasingly being used in structures and buildings as an architectural as well as a structural element. Ancon 500 Tension Systems comprise a range of components which can be supplied in carbon steel or stainless steel in a variety of sizes and finishes. They have a high load capacity and look particularly impressive when used with large areas of glazing or curved timber trusses.



© Darcy Schack JAM Photographics Ltd

Shear Load Connectors

Ancon DSD and ESD Shear Load Connectors are used to transfer shear across expansion and contraction joints in concrete. They are more effective at transferring load and allowing movement to take place than standard dowels, and can be used to eliminate double columns at structural movement joints in buildings. A 'Lockable' dowel is also available for temporary movement joints in post-tensioned concrete frames.



Worldwide contacts for Leviat:

Australia

Leviat
98 Kurrajong Avenue,
Mount Druitt Sydney, NSW 2770
Tel: +61 - 2 8808 3100
Email: info.au@leviat.com

Austria

Leviat
Leonard-Bernstein-Str. 10
Saturn Tower, 1220 Wien
Tel: +43 - 1 - 259 6770
Email: info.at@leviat.com

Belgium

Leviat
Industrielaan 2
1740 Ternat
Tel: +32 - 2 - 582 29 45
Email: info.be@leviat.com

China

Leviat
Room 601 Tower D, Vantone Centre
No. A6 Chao Yang Men Wai Street
Chaoyang District
Beijing · P.R. China 100020
Tel: +86 - 10 5907 3200
Email: info.cn@leviat.com

Czech Republic

Leviat
Business Center Šafránková
Šafránková 1238/1
155 00 Praha 5
Tel: +420 - 311 - 690 060
Email: info.cz@leviat.com

Finland

Leviat
Vädursgatan 5
412 50 Göteborg / Sweden
Tel: +358 (0)10 6338781
Email: info.fi@leviat.com

France

Leviat
6, Rue de Cabanis
FR 31240 L'Union
Toulouse
Tel: +33 - 5 - 34 25 54 82
Email: info.fr@leviat.com

Germany

Leviat
Liebigstrasse 14
40764 Langenfeld
Tel: +49 - 2173 - 970 - 0
Email: info.de@leviat.com

India

Leviat
309, 3rd Floor, Orion Business Park
Ghodbunder Road, Kapurbawdi,
Thane West, Thane,
Maharashtra 400607
Tel: +91 - 22 2589 2032
Email: info.in@leviat.com

Italy

Leviat
Via F.lli Bronzetti 28
24124 Bergamo
Tel: +39 - 035 - 0760711
Email: info.it@leviat.com

Malaysia

Leviat
28 Jalan Anggerik Mokara 31/59
Kota Kemuning, 40460 Shah Alam
Selangor
Tel: +603 - 5122 4182
Email: info.my@leviat.com

Netherlands

Leviat
Oostermaat 3
7623 CS Borne
Tel: +31 - 74 - 267 14 49
Email: info.nl@leviat.com

New Zealand

Leviat
2/19 Nuttall Drive, Hillsborough,
Christchurch 8022
Tel: +64 - 3 376 5205
Email: info.nz@leviat.com

Norway

Leviat
Vestre Svanholmen 5
4313 Sandnes
Tel: +47 - 51 82 34 00
Email: info.no@leviat.com

Philippines

Leviat
2933 Regus, Joy Nostalg,
ADB Avenue
Ortigas Center
Pasig City
Tel: +63 - 2 7957 6381
Email: info.ph@leviat.com

Poland

Leviat
Ul. Obornicka 287
60-691 Poznan
Tel: +48 - 61 - 622 14 14
Email: info.pl@leviat.com

Singapore

Leviat
14 Benoi Crescent
Singapore 629977
Tel: +65 - 6266 6802
Email: info.sg@leviat.com

Spain

Leviat
Poligono Industrial Santa Ana
c/ Ignacio Zuloaga, 20
28522 Rivas-Vaciamadrid
Tel: +34 - 91 632 18 40
Email: info.es@leviat.com

Sweden

Leviat
Vädursgatan 5
412 50 Göteborg
Tel: +46 - 31 - 98 58 00
Email: info.se@leviat.com

Switzerland

Leviat
Grenzstrasse 24
3250 Lyss
Tel: +41 - 31 750 3030
Email: info.ch@leviat.com

United Kingdom

Leviat
President Way, President Park,
Sheffield, S4 7UR
Tel: +44 - 114 275 5224
Email: info.uk@leviat.com

United States of America

Leviat
6467 S Falkenburg Rd.
Riverview, FL 33578
Tel: (800) 423-9140
Email: info.us@leviat.us

For countries not listed

Email: info@leviat.com

Leviat.com

Notes regarding this catalogue

© Protected by copyright. The construction applications and details provided in this publication are indicative only. In every case, project working details should be entrusted to appropriately qualified and experienced persons. Whilst every care has been exercised in the preparation of this publication to ensure that any advice, recommendations or information is accurate, no liability or responsibility of any kind is accepted by Leviat for inaccuracies or printing errors. Technical and design changes are reserved. With a policy of continuous product development, Leviat reserves the right to modify product design and specification at any time.

For more information on the following products, please contact:

**Masonry, Structural and
Precast Concrete products:**

+64 (0) 3 376 5205
info.ancon.nz@leviat.com
Ancon.co.nz

**Remedial Masonry
products:**

+64 (0) 3 376 5205
info.helifix.nz@leviat.com
Helifix.co.nz

General Enquiries

+64 (0) 3 376 5205
Leviat.com

Sales Offices and Production

North Island:

246D James Fletcher Drive
Otahuhu
Auckland 2024
New Zealand

South Island:

2/19 Nuttall Drive
Hillsborough
Christchurch 8022
New Zealand

Leviat.com

Leviat[®]
A CRH COMPANY

Imagine. Model. Make.

[Leviat.com](https://www.leviat.com)